

WIRING DIAGRAMS

MODEL	HEADLIGHT (watt)	TAILLIGHT (watt)	ELECTRICAL SYSTEM OUTPUT (watt)
Tundra R	60/55 hal.	8/27	240
Skandic LT	60/55 hal.	8/27	240
Skandic WT/SWT	60/55 hal.	8/27	240
Skandic WT LC	60/55 hal.	8/27	220

hal. = halogen

WIRING DIAGRAM LEGEND

⚠ WARNING

Ensure all terminals are properly crimped on the wires and all connector housings are properly fastened.

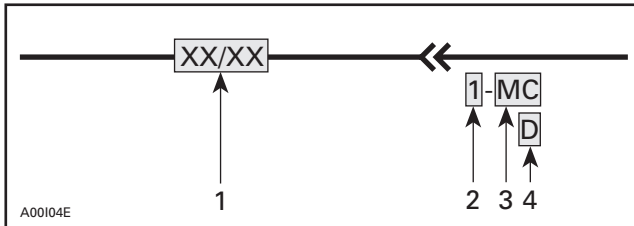

1. Wire colors
2. Housing area
3. Housing number per area
4. Wire connector location in housing

WIRE COLORS AND CIRCUIT

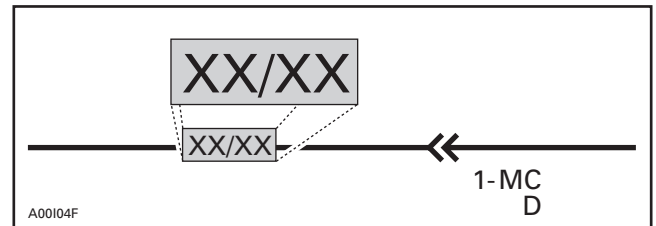

The first color of a wire is the main color, second color is the stripe.

Example: YL/BK is a YELLOW wire with a BLACK stripe.

COLOR CODE					
BE	-	BEIGE	OR	-	ORANGE
BK	-	BLACK	RD	-	RED
BL or BU	-	BLUE	VI	-	VIOLET
BR	-	BROWN	WH	-	WHITE
GN	-	GREEN	YL	-	YELLOW
GY	-	GREY			

Section 11 WIRING DIAGRAMS

Subsection 01 (WIRING DIAGRAMS)

Following table shows wire colors related to electrical circuits.

WIRE COLOR	ELECTRICAL CIRCUIT	ADDITIONAL INFORMATION
BLACK/YELLOW	ENGINE SHUT OFF – key switch – tether cord switch – emergency switch	Must be grounded to stop engine.
BLACK (small)	Ground for shut off, RER pilot lamp, beeper and beeper switch	
BLACK (big)	Ground for starter (-)	
BEIGE	RER switch	Must be grounded to activate RER.
BEIGE/BLACK	Reverse alarm and pilot lamp	Current returns by BLACK wire.
YELLOW YELLOW/BLACK YELLOW/GREEN (Skandic series)	12 volts (AC)	If shorted, magneto stops producing electricity.
RED	12 volts (DC) (+) For starter motor	
RED/GREEN	12 volts (DC) (+) For starter solenoid	
RED/BLUE	12 volts (DC) (+) Rectifier output	
GREY	12 volts (AC) High beam	Current returns by YELLOW/BLACK wire connected to headlamp.
VIOLET/GREY	12 volts (AC) Low beam	
WHITE	12 volts (AC) Brake light	Current returns by YELLOW/BLACK wire connected to taillight.
WHITE/RED	12 volts (AC) Low oil level	Current returns by YELLOW/BLACK wire connected to oil level sensor.
BLUE	12 volts (AC) Fuel level indicator	Current returns by YELLOW wire connected to fuel level sensor.
ORANGE	12 volts (AC) Heated grips (max.)	Current returns by YELLOW/BLACK wire connected to heating elements.
ORANGE/VIOLET	12 volts (AC) Heated grips (min.)	
BROWN	12 volts (AC) Heated throttle lever (max.)	
BROWN/YELLOW	12 volts (AC) Heated throttle lever (min.)	
GREEN	12 volts (AC) Temperature gauge	Current returns by YELLOW wire connected to sensor.
VIOLET	12 volts (AC) Engine overheating light	

CONNECTOR HOUSING AREA

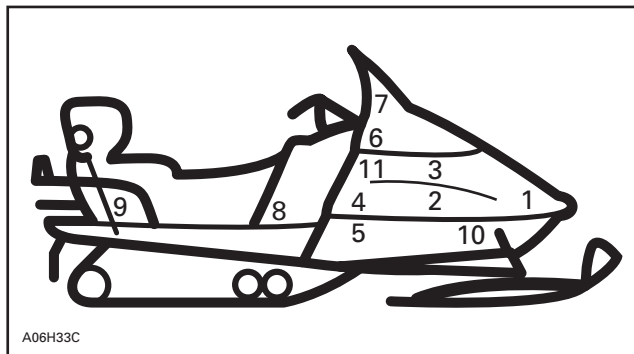
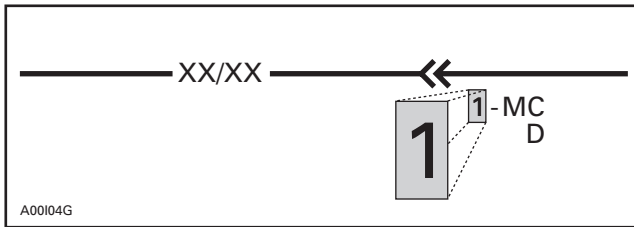

AREA	LOCATION
1	Front of engine compartment
2	Magneto
3	Carburetors
4	Near of intake silencer
5	Near driven pulley
6	Under console
7	Under hood
8	Near fuel tank
9	Rear of seat
10	Under engine
11	On injection oil reservoir

CONNECTOR LOCATION IN HOUSING

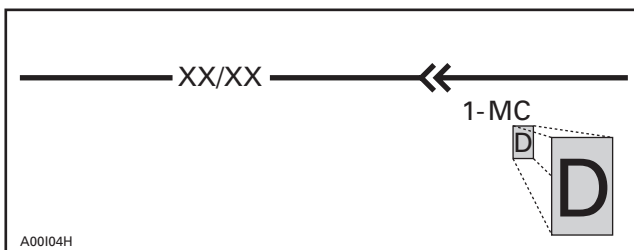





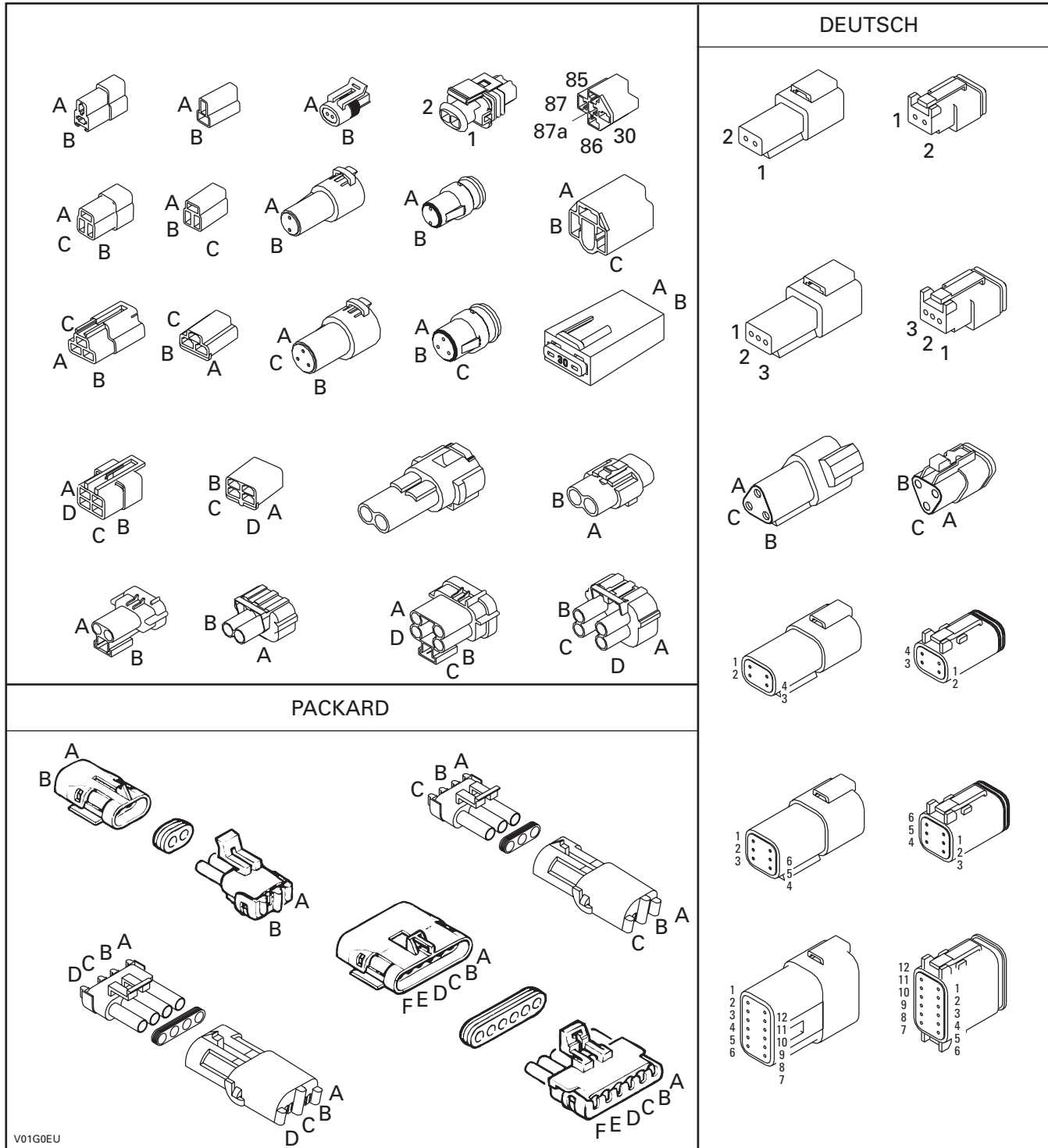





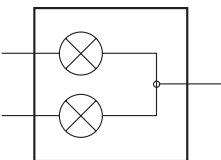
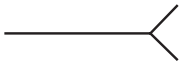
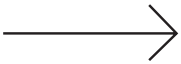
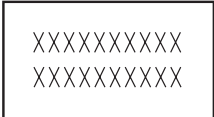
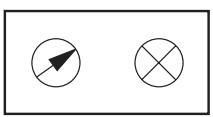

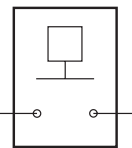
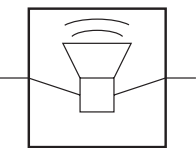
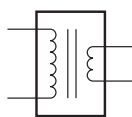
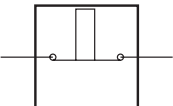
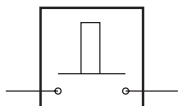
Section 11 WIRING DIAGRAMS

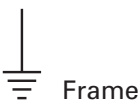
Subsection 01 (WIRING DIAGRAMS)

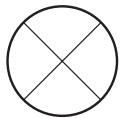
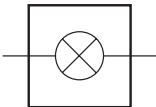
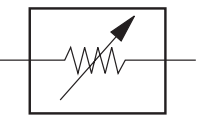
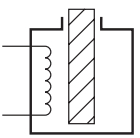

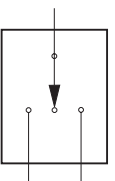
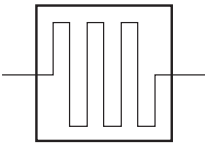
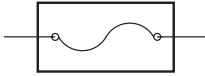
V01G0EU

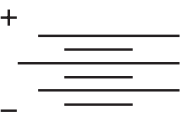
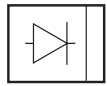
SYMBOLS DESCRIPTION

<p>Beam and tail light</p> 	<p>Female terminal</p> 	<p>Male terminal</p> 	<p>Electronic module</p> 
<p>Meter</p> 	<p>Electric motor</p> 	<p>Low level sensor</p> 	<p>Buzzer</p> 
<p>Ignition coil</p> 	<p>Normally close switch</p> 	<p>Normally open switch</p> 	<p>Male terminal on instrument</p> 
<p>Engine ground</p> 	<p>Frame ground</p> 	<p>Spark plug</p> 	<p>Meter movement</p> 
<p>Bulb</p> 	<p>Pilot</p> 	<p>Analog sensor</p> 	<p>Solenoid valve</p> 
<p>Magneto (Delta)</p> 	<p>3 position switch</p> 	<p>Heating element</p> 	<p>Fuse</p> 
<p>Trigger coil</p> 	<p>Battery</p> 	<p>Diode</p> 	<p>Partially illustrated component</p> 

A00E55S

Section 11 WIRING DIAGRAMS

Subsection 01 (WIRING DIAGRAMS)

UNPLUGGING CONNECTORS

Always unplug connectors by pulling on housing not on wire.

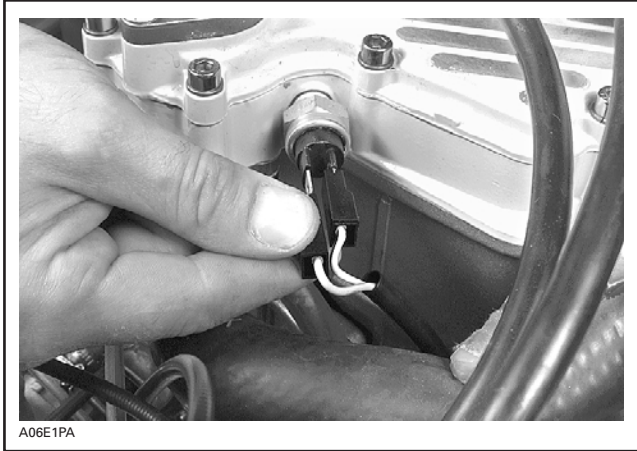

TYPICAL

TAB AND RECEPTACLE CONNECTOR REMOVAL

Tab Connector

It is locked in its housing by a spring tab on its side. Removal is done by squeezing this tab.

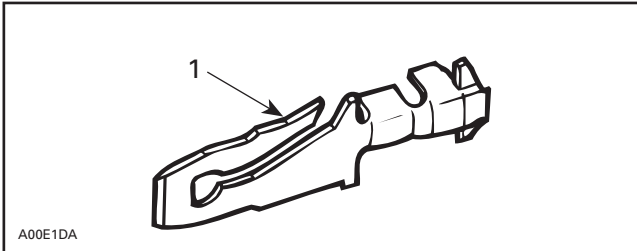

TAB CONNECTOR

1. Locking tab

To remove:

- Insert a screwdriver or Snap-on TT 600-5 from opposite side of wire and pry locking tab.
- While holding locking tab pried, pull connector toward wire side.

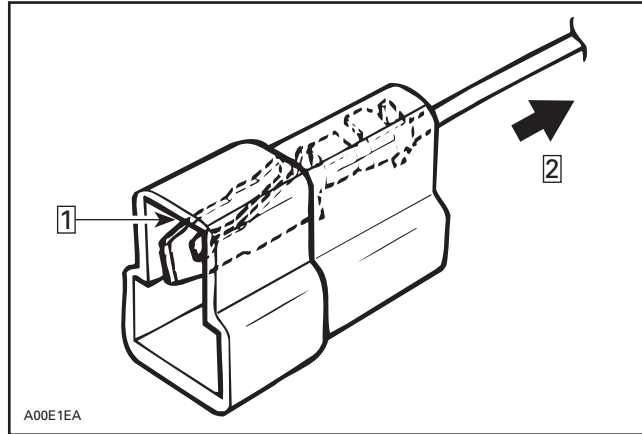

Step 1: Insert screwdriver here

Step 2: Pull this side

Locking Receptacle Connector

To remove:

- Insert tool Snap-on TT 600-5 in access opening then pull housing toward wire side.

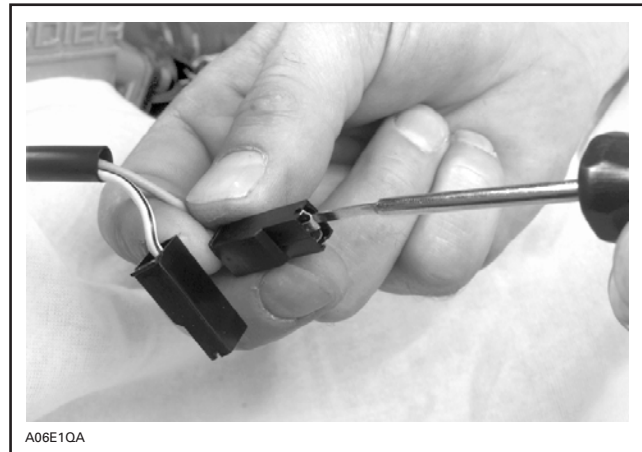

Waterproof Connector Housing

Female Connector Housing

To remove:

- Insert tool Snap-on TT 600-5 under lock and twist to lift it.

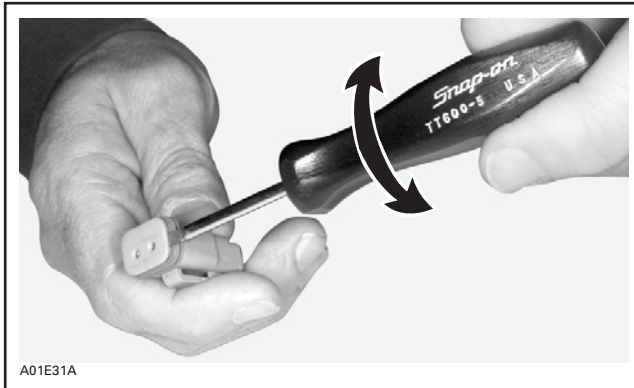

- Pry tab to free connector then pull wire out of housing.

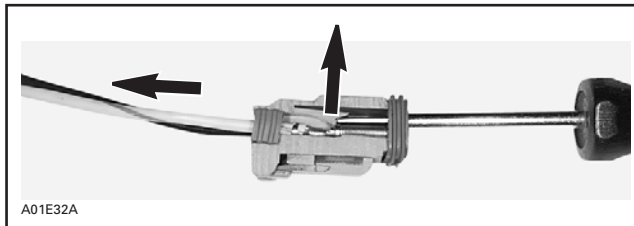

FEMALE CONNECTOR HOUSING — CUT-AWAY

Male Connector Housing

To remove:

- Using a small hook, pull out the lock.

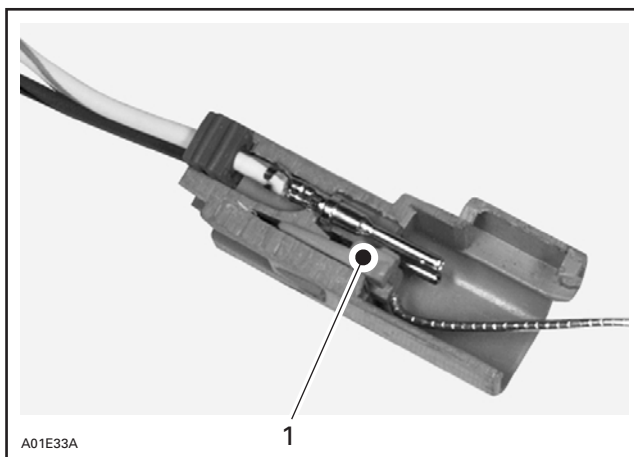

1. Lock

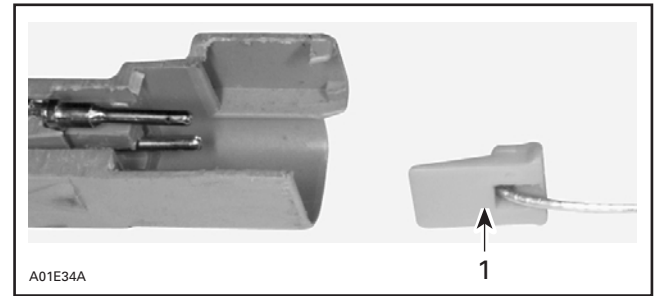

1. Lock

- Pry tab to free connector then pull wire out of housing.

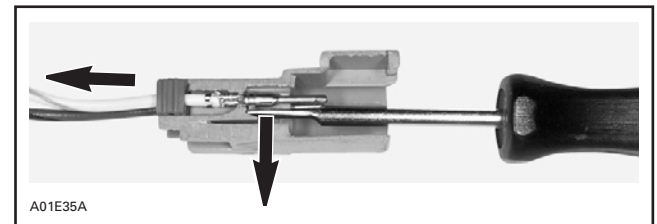

MALE CONNECTOR HOUSING — CUT-AWAY

TAB AND RECEPTACLE CONNECTOR INSTALLATION

Prior to installing a connector, make sure locking tab is sufficiently lifted to properly lock.

Insert tab and receptacle connectors in their respective housings as shown in following illustrations. Push sufficiently so that they snap. Try pulling wire to ensure they are properly locked.

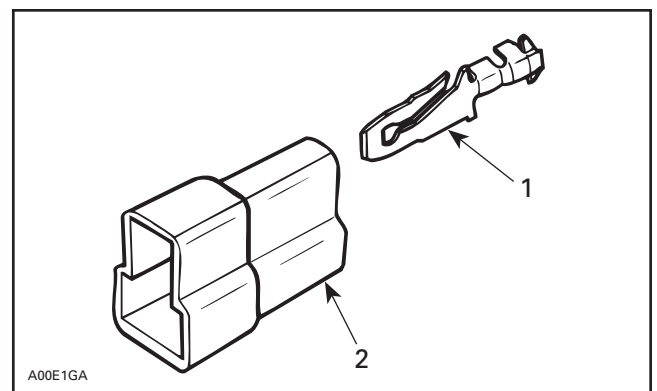

1. Tab
 2. Housing

Section 11 WIRING DIAGRAMS

Subsection 01 (WIRING DIAGRAMS)

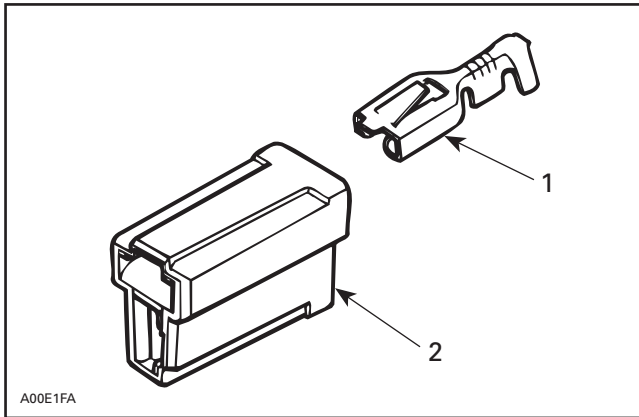

TYPICAL

1. Receptacle
2. Housing

ACCESSORIES INSTALLATION

On all **electric start models**: The direct current (DC) utilizes the snowmobile frame as ground "wire" while all alternating current (AC) consumers (lights, heated grips, fuel gauge, etc.) utilize a separate ground wire.

Never interconnect AC and DC grounds as an AC voltage drop will result. When installing accessories on **any** snowmobile, connect their wires directly to the YELLOW and YELLOW/BLACK lighting coil wires.

Even if **manual start models** have an AC ground to the chassis (on voltage regulator), all accessories utilize a ground wire isolated from chassis. When an electric starter kit is installed, the voltage regulator and its ground wire are replaced by a voltage rectifier/regulator unit permitting a completely isolated AC circuit.

WARNING

Never secure electrical wires/cables with fuel lines. Keep wires away from any rotating, moving, heating, vibrating or sharp edge. Use proper fastening devices as required.

2002 SKANDIC LT

2002 SKANDIC LT

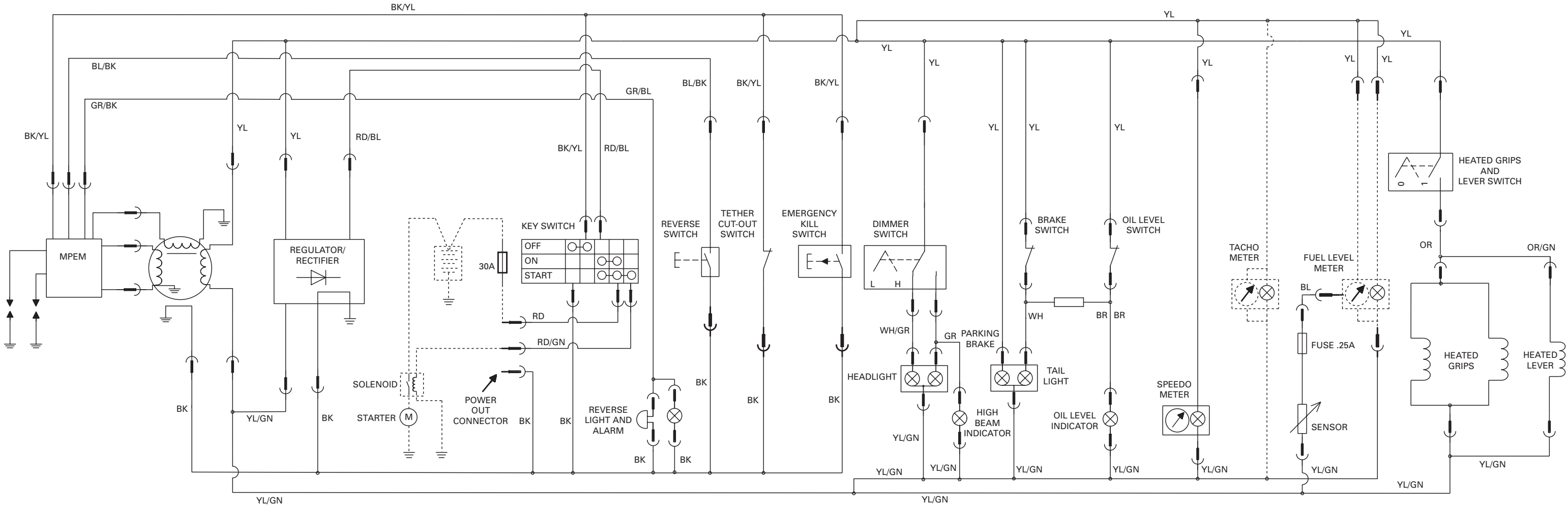

2002 SKANDIC WT LC

2002 SKANDIC WT LC

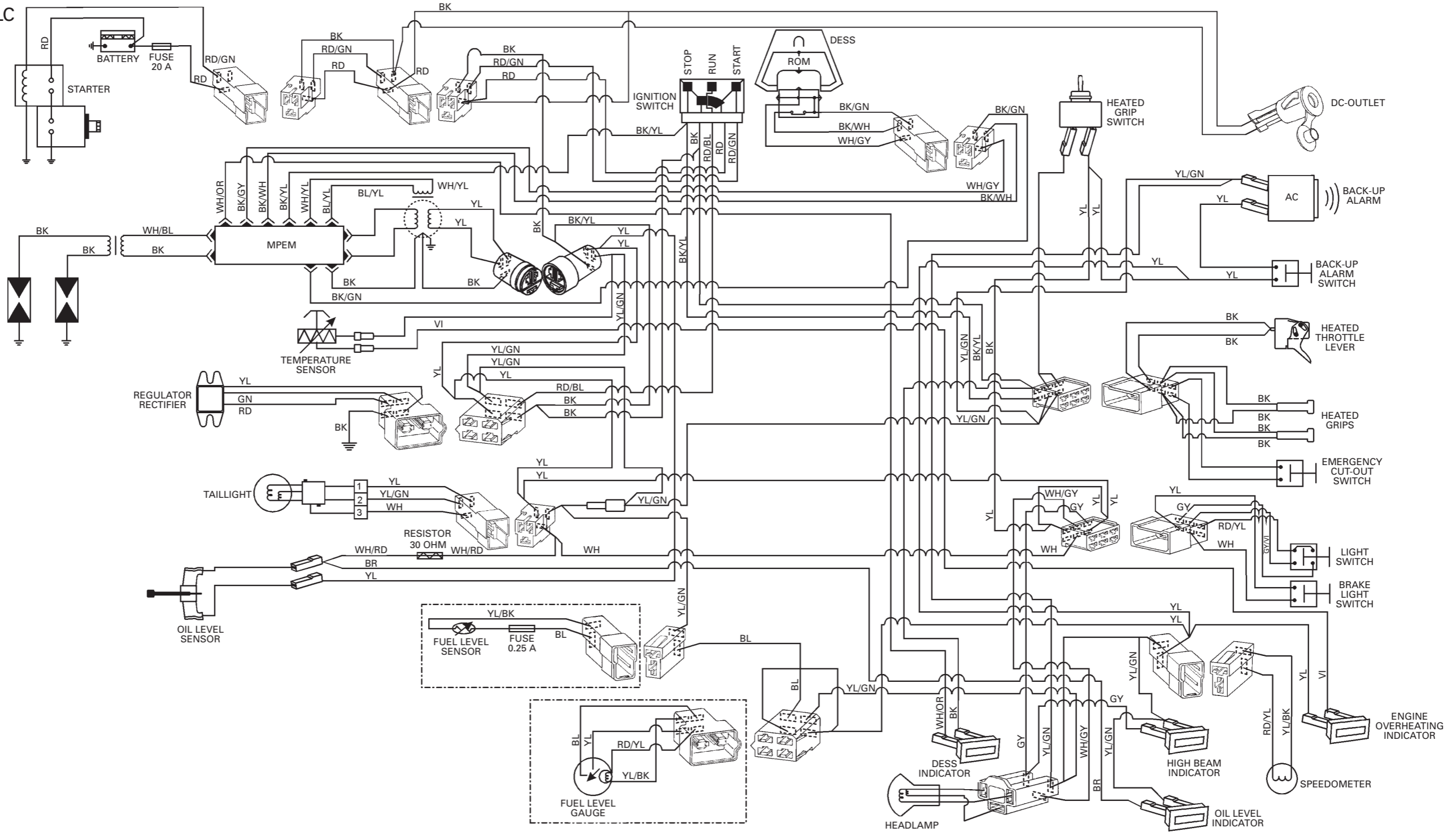

2002 SKANDIC WT/SWT

2002 SKANDIC WT/SWT

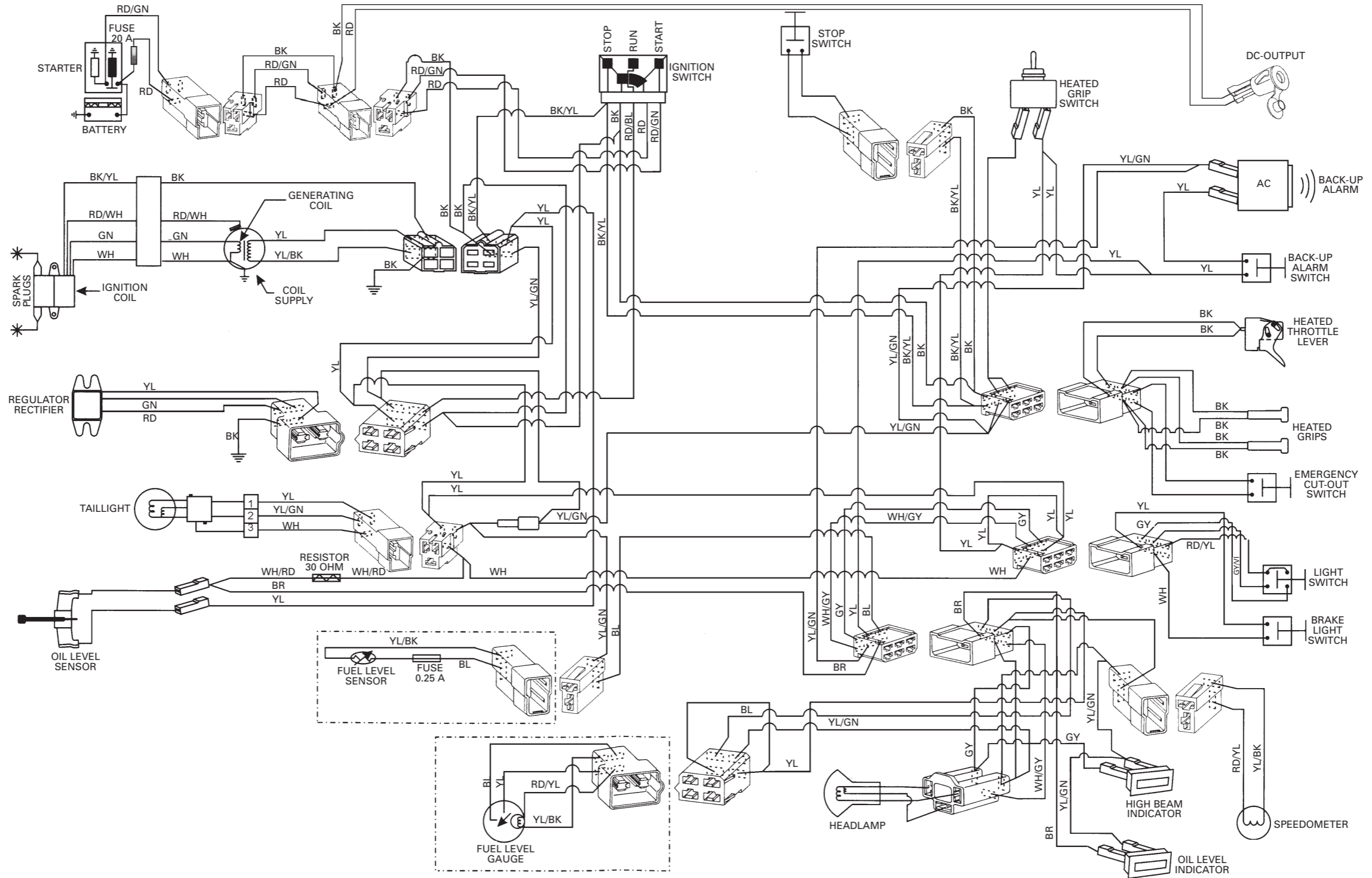

ski-doo[®]
2002

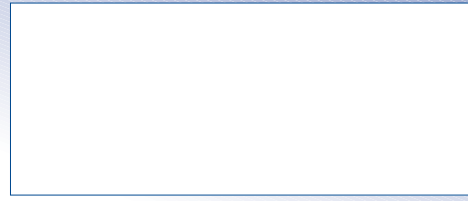

©™Trademarks of Bombardier Inc. or its subsidiaries.
© 2001 Bombardier Inc. All rights reserved.
Printed in Canada.



SKI-DOO[®]

Shop Manual
Volume 1

2002

ski-doo[®]
2002

**Shop
Manual**

Volume 1

**Tundra R
Skandic**
LT/WT/SWT/WT LC



484 200 032