



ski-doo®

2002

Operator's Guide



WARNING

Read this guide thoroughly.
It contains important safety information.

Mini Z

484 100 056

SAFETY WARNING

Disregarding any of the safety precautions and instructions contained in this *Operator's Guide* or on-product warnings may result in injury, including the possibility of death.

This *Operator's Guide* should remain with the unit at time of resale.

BOMBARDIER
RECREATIONAL PRODUCTS



In USA, products are distributed by Bombardier Motor Corporation of America. In Canada, products are distributed by Bombardier Inc.

The following are trademarks of Bombardier Inc.

BOMBARDIER®
MINI Z™

Kleen-Flo* is a trademark of Kleen-Flo Tumbler Industries Ltd.

FOREWORD

Congratulations on your purchase of a new SKI-DOO snowmobile. Whatever model you have chosen, it is backed by the Bombardier warranty and a network of authorized Ski-Doo snowmobile dealers ready to provide the parts, service or accessories you may require.

Your dealer is committed to your satisfaction. He has taken training to perform the initial set-up and inspection of your snowmobile as well as completed the final adjustments before you took possession. At delivery, your dealer would have explained the snowmobile controls. We trust you have taken full advantage of this! If you need more complete servicing information, please ask your dealer about the *Ski-Doo Mini Z Shop Manual*.

At delivery, you were also informed of the warranty coverage and completed the Warranty Registration Form which is to be sent to us for processing.

NOTICE TO PARENTS

Review this guide with any user of this snowmobile.

Please take time with the children to review the instructions on its safe and proper use, while paying attention to the on-product safety labeling before allowing them to ride snowmobile.

Understand the controls and operation of the snowmobile, carefully read the *Operator's Guide*, pay attention to the on-product safety labeling and review them with the children before allowing them to ride.

It is important that you supervise the children at all times in order to prevent serious injuries. It is at your discretion to allow unsupervised use only if you should pre-determine that all children have the ability strength and judgment to operate the snowmobile safely.

Do not allow children to ride snowmobile if they are younger than the recommended age of 6 years (or weighing over 100 lbs) or if they do not have the strength, skills or judgment required to operate the snowmobile. Always remember that your approach to safety influences the child. If available locally, enroll your children in a snowmobile safety training program.

THIS GUIDE SHOULD REMAIN WITH THE SNOWMOBILE AT ITS RESALE.

TABLE OF CONTENTS

SAFETY	6
SAFETY LABELING	7
BOMBARDIER LIMITED WARRANTY NORTH AMERICA: 2002 SKI-DOO® SNOWMOBILES	9
BOMBARDIER LIMITED WARRANTY INTERNATIONAL: 2002 SKI-DOO® SNOWMOBILES	12
AUTHORIZED SKI-DOO DEALERS	15

CHILD'S SECTION	16
SNOWMOBILE DESCRIPTION	17
CLOTHING	18
SNOWMOBILE CONTROLS	19
1) Throttle Lever	20
2) Brake Lever	20
3) Ignition Switch	21
4) Tether Cut-Out Switch	22
5) Engine Cut-Out Switch	23
6) Rewind Starter Handle	23
7) Choke Button	24
8) Hood Latches	24
BEFORE YOU START	25
Throttle.....	25
Brake	26
Visual Inspection	27
Track	28
HOW TO START	29
HOW TO STOP	33
EMERGENCY STOP	34
FIRST RIDE	35

HOW TO RIDE	36
Sitting	36
Kneeling.....	37
Standing	38
Passenger.....	39
People at Front.....	39
SIGNALS	40
Stop.....	40
Left Turn.....	41
Right Turn.....	42
AFTER USE.....	42
<hr/>	
PARENT'S SECTION.....	43
HOW TO IDENTIFY YOUR SNOWMOBILE	44
Vehicle Identification Number Location.....	44
Engine Serial Number Location.....	45
ON-VEHICLE IMPORTANT INSTRUCTIONS.....	46
Chain Guard.....	46
Hood (above footrest).....	47
FUEL AND OIL.....	48
Recommended Fuel	48
Recommended Oil	50
Engine Oil Level	51
BREAK-IN PERIOD	53
Engine	53
10-Hour Inspection	53
PRE-OPERATION CHECK	54
PRE-OPERATION CHECK LIST.....	55
STARTING PROCEDURE	56
Manual Starting	56

REPAIR AND MAINTENANCE	57
Vehicle Cleaning and Protection	58
Chain Guard Removal and Installation	59
Clutch Axle and Drive Chain Lubrication	59
Drive Chain Tension	61
Brake Condition.....	61
Brake Adjustment	62
Rear Suspension Condition	64
Suspension Stopper Straps Condition	64
Track Condition	64
Track Tension and Alignment.....	64
Steering and Front Suspension Mechanism	68
Wear and Condition of Skis and Runners	69
Exhaust System	69
Bulb Replacement.....	69
STORAGE AND PRESEASON PREPARATION	71
Storage.....	71
Preseason Preparation	71
TROUBLESHOOTING	72
SPECIFICATIONS.....	74
LUBRICATION AND MAINTENANCE CHART	75
CHANGE OF ADDRESS OR OWNERSHIP	77

SAFETY

This guide uses the following symbols.

WARNING

Identifies an instruction which, if not followed, could cause serious personal injuries including possibility of death.

CAUTION: Denotes an instruction which, if not followed, could severely damage snowmobile components.

NOTE: Indicates supplementary information needed to fully complete an instruction.

WARNING

This snowmobile is classified as a children snowmobile. It is not designed to exceed speeds of 13 km/h (8 MPH), nor to carry passenger(s), cargo, pull a sleigh, toboggan or any object of similar nature.

Children should only be allowed to use the snowmobile in the presence or under the supervision of an adult.

Instruct children thoroughly as to the use of the snowmobile and ensure they are familiar with the snowmobile controls, area of use and riding practices before allowing them to operate the snowmobile.

Use of snowmobile should be limited to daylight operation only, in areas clear of obstacles and on adequate snow covered terrain. Ensure children do not operate the snowmobile on frozen bodies of water, or on snowmobile or ATV recreational trails or near streets, roadways, driveways or sidewalks.

Make sure area is free of wire fencing, tree stumps or other hazards.

Always make sure children wear all appropriate protective clothing including an approved safety helmet.

Always keep the snowmobile well serviced and maintained. Respect and comply with the manufacturer's recommended instructions as to the maintenance, service and storage of the snowmobile.

Do not modify or alter the snowmobile and/or any component. Ensure the hood is always closed and all guards are in place.

SAFETY LABELING

Safety standards for snowmobiles have been adopted by the Snowmobile Safety and Certification Committee of which Bombardier is a proud participating member. Assurance that your snowmobile meets these standards is easily checked by locating the Certification Label on a right vertical portion of the vehicle.

This label signifies that an independent testing laboratory has verified compliance with the SSCC safety standards. Other important labels on the vehicle are WARNING or CAUTION labels relating to maintenance and/or snowmobile operation. Ensure all such labeling is retained on the vehicle and its content is followed by vehicle operators.

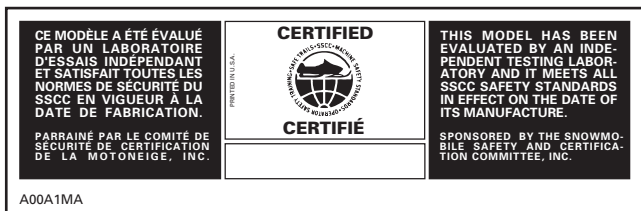

Observe the Following Warnings:

Do not allow children to refuel the snowmobile or attempt any repairs or servicing.

Securely attach the tether cord to the child's body prior to starting the engine.

Ensure that children do not operate snowmobile on snowmobile or ATV recreational trails or near streets, roadways, driveways or sidewalks. In most States and Provinces, it is considered an illegal operation.

Throttle mechanism should be checked for free movement before starting engine.

The snowmobile engine can be stopped by activating the engine cut-out switch, pulling the tether cord or turning off the key.

Engine should be running only when chain guard is secured in place. Never run the engine without drive chain installed. Running an unloaded engine can prove to be dangerous.

Never run the engine when the track is raised off the ground or with the hood opened or removed.

Maintain the snowmobile in top mechanical condition at all times.

Do not lubricate throttle and/or brake cables and housings.

Only perform procedures as detailed in this guide. Unless otherwise specified, engine should be turned OFF and cold for all lubrication and maintenance procedures.

This snowmobile is designed for the driver only and no provisions have been made for a passenger.

The engine and components used in this particular model should not be used on any other type of equipment.

Most components of this snowmobile are built with parts dimensioned in the metric system. Most fasteners are metric and must not be replaced by customary fasteners or vice versa.

BOMBARDIER LIMITED WARRANTY NORTH AMERICA: 2002 SKI-DOO® SNOWMOBILES

1. SCOPE OF THE LIMITED WARRANTY

BOMBARDIER INC. (hereinafter "BOMBARDIER") warrants its 2002 SKI-DOO snowmobiles from defects in material or workmanship for the period described below.

All genuine BOMBARDIER parts and accessories, installed by an authorized BOMBARDIER dealer (as hereinafter defined) at the time of delivery of the 2002 SKI-DOO snowmobile, carry the same warranty as that of the snowmobile.

Use of the product for racing or any other competitive activity, at any point, even by a prior owner will render this warranty null and void.

2. WARRANTY COVERAGE PERIOD

This warranty will be in effect FROM THE DATE OF DELIVERY TO THE FIRST RETAIL CONSUMER or the date the product is first put into use, whichever occurs first and for a period of:

- a. TWELVE (12) CONSECUTIVE MONTHS, for private use owners. The warranty coverage period on a snowmobile delivered between June 1st and December 1st of a given year will expire December 1st of the following year; or
- b. TWELVE (12) CONSECUTIVE MONTHS, for commercial use owners. The warranty coverage period on a snowmobile delivered between June 1st and December 1st of a given year will expire December 1st of the following year.

The repair or replacement of parts or the performance of service under this warranty does not extend the life of this warranty beyond its original expiration date.

3. CONDITIONS TO HAVE WARRANTY COVERAGE

This warranty coverage is available only on 2002 SKI-DOO snowmobile purchased as new and unused by its first owner from a BOMBARDIER dealer authorized to distribute SKI-DOO products in the country in which the sale occurred (hereinafter "BOMBARDIER dealer"), and then only after the BOMBARDIER specified pre-delivery inspection process is completed and documented. Warranty coverage only becomes available upon proper registration of the product by a BOMBARDIER dealer. Such limitations are necessary in order to allow BOMBARDIER to preserve both the safety of its products, and also that of its consumers and the public.

Routine maintenance outlined in the *Operator's Guide* must be timely performed in order to maintain warranty coverage. BOMBARDIER reserves the right to make warranty coverage contingent upon proof of proper maintenance.

4. WHAT TO DO TO OBTAIN WARRANTY COVERAGE

The customer must notify a servicing BOMBARDIER dealer within two (2) days of the appearance of a defect, and provide it with reasonable access to the product and reasonable opportunity to repair it. The customer must also present to the BOMBARDIER dealer, proof of purchase of the product and must sign the repair/work order prior to the start of the repair in order to validate the warranty repair. All parts replaced under this limited warranty become the property of BOMBARDIER.

5. WHAT BOMBARDIER WILL DO

BOMBARDIER's obligations under this warranty are limited to, at its sole discretion, repairing parts found defective under normal use, maintenance and service, or replacing such parts with new genuine BOMBARDIER parts without charge for parts and labor, at any authorized BOMBARDIER dealer.

BOMBARDIER reserves the right to improve or modify products from time to time without assuming any obligation to modify products previously manufactured.

6. EXCLUSIONS - ARE NOT WARRANTED

- Normal wear and tear;
- Routine maintenance items, tune ups, adjustments;
- Damage caused by failure to provide proper maintenance and/or storage, as described in the *Operator's Guide*;
- Damage resulting from removal of parts, improper repairs, service, maintenance, modifications or use of parts not manufactured or approved by BOMBARDIER or resulting from repairs done by a person that is not an authorized servicing BOMBARDIER dealer;
- Damage caused by abuse, abnormal use, neglect, use of the product on surfaces other than snow, or operation of the product in a manner inconsistent with the recommended operation described in the *Operator's Guide*;
- Damage resulting from accident, submersion, fire, theft, vandalism or any act of God;
- Operation with fuels, oils or lubricants which are not suitable for use with the product (see the *Operator's Guide*);
- Snow or water ingestion;
- Incidental or consequential damages, or damages of any kind including without limitation towing, storage, telephone, rental, taxi, inconvenience, insurance coverage, loan payments, loss of time, loss of income; and
- Damage resulting from tracks which have been studded.

7. LIMITATIONS OF LIABILITY

THIS WARRANTY IS EXPRESSLY GIVEN AND ACCEPTED IN LIEU OF ANY AND ALL OTHER WARRANTIES, EXPRESSED OR IMPLIED, INCLUDING WITHOUT LIMITATION ANY WARRANTY OF MERCHANTABILITY OR FITNESS FOR A PARTICULAR PURPOSE. TO THE EXTENT THAT THEY CANNOT BE DISCLAIMED, THE IMPLIED WARRANTIES ARE LIMITED IN DURATION TO THE LIFE OF THE EXPRESS WARRANTY. INCIDENTAL AND CONSEQUENTIAL DAMAGES ARE EXCLUDED FROM COVERAGE UNDER THIS WARRANTY. SOME STATES/PROVINCES DO NOT ALLOW FOR THE DISCLAIMERS, LIMITATIONS AND EXCLUSIONS IDENTIFIED ABOVE, AS A RESULT, THEY MAY NOT APPLY TO YOU. THIS WARRANTY GIVES YOU SPECIFIC RIGHTS, AND YOU MAY ALSO HAVE OTHER LEGAL RIGHTS WHICH MAY VARY FROM STATE TO STATE, OR PROVINCE TO PROVINCE.

Neither the distributor, any BOMBARDIER dealer nor any other person has been authorized to make any affirmation, representation or warranty regarding the product, other than those contained in this limited warranty, and if made, shall not be enforceable against BOMBARDIER.

BOMBARDIER reserves the right to modify this warranty at any time, being understood that such modification will not alter the warranty conditions applicable to the products sold while this warranty is in effect.

8. TRANSFER

If the ownership of a product is transferred during the warranty coverage period, this warranty shall also be transferred and be valid for the remaining coverage period provided that BOMBARDIER is notified of such transfer of ownership in the following way:

- a. The former owner contacts BOMBARDIER (at the phone number provided below) or an authorized BOMBARDIER dealer and gives the coordinates of the new owner; or
- b. BOMBARDIER or an authorized BOMBARDIER dealer receives a proof that the former owner agreed to the transfer of ownership, in addition to the coordinates of the new owner.

9. CONSUMER ASSISTANCE

- a. In the event of a controversy or a dispute in connection with this BOMBARDIER LIMITED WARRANTY, BOMBARDIER suggests that you try to resolve the issue at the dealership level. We recommend discussing the issue with the authorized dealer's service manager or owner.
- b. If the issue has not yet been resolved, please submit your complaint in writing or call the appropriate number below:

In Canada:

BOMBARDIER INC.
RECREATIONAL PRODUCTS
SKI-DOO®
CUSTOMER ASSISTANCE CENTER
VALCOURT QC J0E 2L0
Tel: (819) 566-3366

In USA:

BOMBARDIER MOTOR
CORPORATION OF AMERICA
RECREATIONAL PRODUCTS
SKI-DOO®
CUSTOMER ASSISTANCE CENTER
P.O. BOX 8035
7575 BOMBARDIER COURT
WAUSAU WI 54402-8035
Tel: (715) 848-4957



BOMBARDIER
RECREATIONAL PRODUCTS

© 2000 Bombardier Inc. All rights reserved

® Registered trademark of Bombardier Inc.

BOMBARDIER LIMITED WARRANTY INTERNATIONAL: 2002 SKI-DOO® SNOWMOBILES

1. SCOPE OF THE LIMITED WARRANTY

BOMBARDIER INC. (hereinafter "BOMBARDIER") warrants its 2002 SKI-DOO snowmobiles from defects in material or workmanship for the period described below.

All genuine BOMBARDIER parts and accessories, installed by an authorized BOMBARDIER distributor/dealer (as hereinafter defined) at the time of delivery of the 2002 SKI-DOO snowmobile, carry the same warranty as that of the snowmobile.

Use of the product for racing or any other competitive activity, at any point, even by a prior owner will render this warranty null and void.

2. WARRANTY COVERAGE PERIOD

This warranty will be in effect FROM THE DATE OF DELIVERY TO THE FIRST RETAIL CONSUMER or the date the product is first put into use, whichever occurs first and for a period of:

- a. TWELVE (12) CONSECUTIVE MONTHS, for private use owners. The warranty coverage period on a snowmobile delivered between June 1st and December 1st of a given year will expire December 1st of the following year; or
- b. TWELVE (12) CONSECUTIVE MONTHS, for commercial use owners. The warranty coverage period on a snowmobile delivered between June 1st and December 1st of a given year will expire December 1st of the following year.

The repair or replacement of parts or the performance of service under this warranty does not extend the life of this warranty beyond its original expiration date.

3. CONDITIONS TO HAVE WARRANTY COVERAGE

This warranty coverage is available only on 2002 SKI-DOO snowmobile purchased as new and unused by its first owner from a BOMBARDIER distributor/dealer authorized to distribute SKI-DOO products in the country in which the sale occurred (hereinafter "BOMBARDIER distributor/dealer"), and then only after the BOMBARDIER specified pre-delivery inspection process is completed and documented. Warranty coverage only becomes available upon proper registration of the product by a BOMBARDIER dealer. Such limitations are necessary in order to allow BOMBARDIER to preserve both the safety of its products, and also that of its consumers and the public.

Routine maintenance outlined in the *Operator's Guide* must be timely performed in order to maintain warranty coverage. BOMBARDIER reserves the right to make warranty coverage contingent upon proof of proper maintenance.

4. WHAT TO DO TO OBTAIN WARRANTY COVERAGE

The customer must notify a servicing BOMBARDIER distributor/dealer within two (2) days of the appearance of a defect, and provide it with reasonable access to the product and reasonable opportunity to repair it. The customer must also present to the BOMBARDIER dealer, proof of purchase of the product and must sign the repair/work order prior to the start of the repair in order to validate the warranty repair. All parts replaced under this limited warranty become the property of BOMBARDIER.

5. WHAT BOMBARDIER WILL DO

BOMBARDIER's obligations under this warranty are limited to, at its sole discretion, repairing parts found defective under normal use, maintenance and service, or replacing such parts with new genuine BOMBARDIER parts without charge for parts and labor, at any authorized BOMBARDIER distributor/dealer.

BOMBARDIER reserves the right to improve or modify products from time to time without assuming any obligation to modify products previously manufactured.

6. EXCLUSIONS - ARE NOT WARRANTED

- Normal wear and tear;
- Routine maintenance items, tune ups, adjustments;
- Damage caused by failure to provide proper maintenance and/or storage, as described in the *Operator's Guide*;
- Damage resulting from removal of parts, improper repairs, service, maintenance, modifications or use of parts not manufactured or approved by BOMBARDIER or resulting from repairs done by a person that is not an authorized servicing BOMBARDIER dealer;
- Damage caused by abuse, abnormal use, neglect, use of the product on surfaces other than snow, or operation of the product in a manner inconsistent with the recommended operation described in the *Operator's Guide*;
- Damage resulting from accident, submersion, fire, theft, vandalism or any act of God;
- Operation with fuels, oils or lubricants which are not suitable for use with the product (see the *Operator's Guide*);
- Snow or water ingestion;
- Incidental or consequential damages, or damages of any kind including without limitation towing, storage, telephone, rental, taxi, inconvenience, insurance coverage, loan payments, loss of time, loss of income; and
- Damage resulting from tracks which have been studded.

7. LIMITATIONS OF LIABILITY

THIS WARRANTY IS EXPRESSLY GIVEN AND ACCEPTED IN LIEU OF ANY AND ALL OTHER WARRANTIES, EXPRESSED OR IMPLIED, INCLUDING WITHOUT LIMITATION ANY WARRANTY OF MERCHANTABILITY OR FITNESS FOR A PARTICULAR PURPOSE. TO THE EXTENT THAT THEY CANNOT BE DISCLAIMED, THE IMPLIED WARRANTIES ARE LIMITED IN DURATION TO THE LIFE OF THE EXPRESS WARRANTY. INCIDENTAL AND CONSEQUENTIAL DAMAGES ARE EXCLUDED FROM COVERAGE UNDER THIS WARRANTY. SOME STATES/PROVINCES DO NOT ALLOW FOR THE DISCLAIMERS, LIMITATIONS AND EXCLUSIONS IDENTIFIED ABOVE, AS A RESULT, THEY MAY NOT APPLY TO YOU. THIS WARRANTY GIVES YOU SPECIFIC RIGHTS, AND YOU MAY ALSO HAVE OTHER LEGAL RIGHTS WHICH MAY VARY FROM STATE TO STATE, OR PROVINCE TO PROVINCE.

Neither the distributor, any BOMBARDIER dealer nor any other person has been authorized to make any affirmation, representation or warranty regarding the product, other than those contained in this limited warranty, and if made, shall not be enforceable against BOMBARDIER.

BOMBARDIER reserves the right to modify this warranty at any time, being understood that such modification will not alter the warranty conditions applicable to the products sold while this warranty is in effect.

8. TRANSFER

If the ownership of a product is transferred during the warranty coverage period, this warranty shall also be transferred and be valid for the remaining coverage period provided that BOMBARDIER is notified of such transfer of ownership in the following way:

- a. The former owner contacts BOMBARDIER or an authorized BOMBARDIER distributor/dealer and gives the coordinates of the new owner; or
- b. BOMBARDIER or an authorized BOMBARDIER distributor/dealer receives a proof that the former owner agreed to the transfer of ownership, in addition to the coordinates of the new owner.

9. CONSUMER ASSISTANCE

- a. In the event of a controversy or a dispute in connection with this BOMBARDIER LIMITED WARRANTY, BOMBARDIER suggests that you try to resolve the issue at the distributorship/dealership level. We recommend discussing the issue with the authorized dealer's service manager or owner.
- b. If further assistance is required, the distributor's service department should be contacted in order to resolve the matter.



BOMBARDIER *RECREATIONAL PRODUCTS*

© 2000 Bombardier Inc. All rights reserved

® Registered trademark of Bombardier Inc.

AUTHORIZED SKI-DOO DEALERS

For Canada and USA

To find the nearest authorized SKI-DOO dealer, dial: 1-800-375-4366.

CHILD'S SECTION

SNOWMOBILE DESCRIPTION

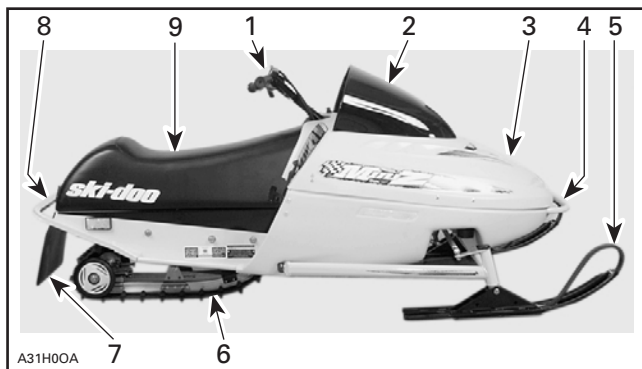

1. Handlebar
2. Windshield
3. Hood
4. Front bumper
5. Skis
6. Track
7. Snow guard
8. Rear bumper
9. Seat

CLOTHING

Always wear all appropriate protective clothing including an approved safety helmet.

User(s) should be adequately clothed. Do not permit loose clothing which could be entangled in moving parts or get snagged on tree branches.

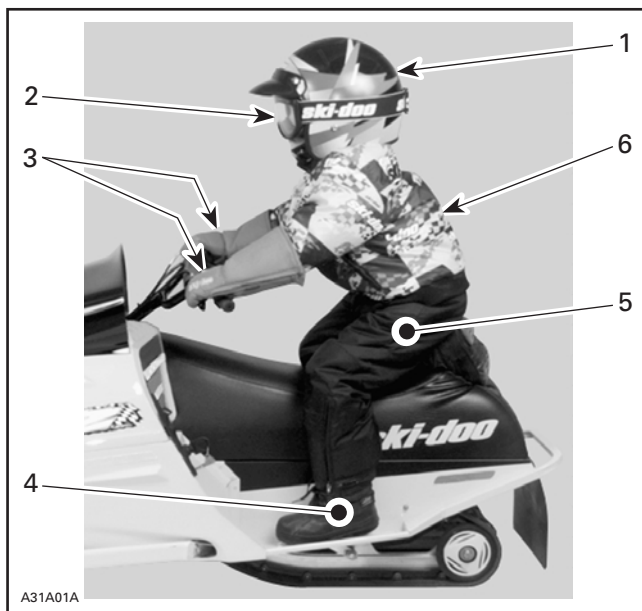

1. Safety helmet
2. Goggles
3. Mittens
4. Warm-up boots
5. Warm-up pants
6. Jacket

SNOWMOBILE CONTROLS

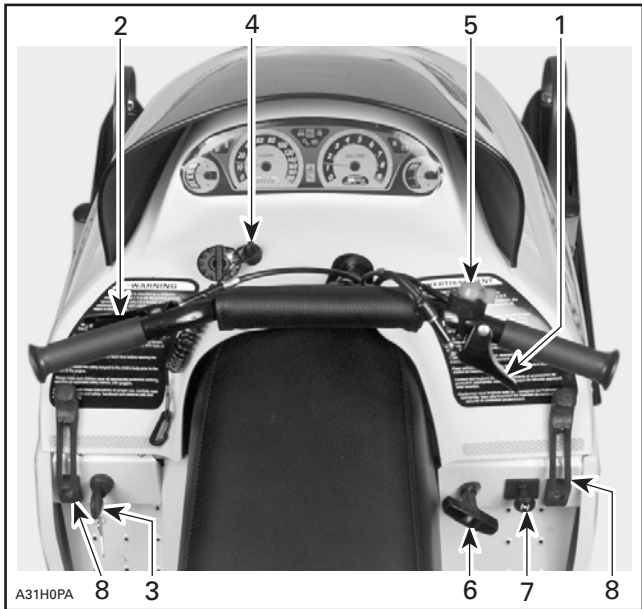

1. Throttle lever
2. Brake lever
3. Ignition switch
4. Tether cut-out switch
5. Engine cut-out switch
6. Rewind starter handle
7. Choke button
8. Hood latches

1) Throttle Lever

Squeezing the lever with your thumb will make the snowmobile go faster. Releasing the lever slows the snowmobile.

WARNING

Test the throttle lever operation each time you want to start the engine. This must be done before starting. The lever must return to its original position once released.

2) Brake Lever

Squeezing the brake lever toward the handlebar slows and stops the snowmobile. The throttle lever should also be released to bring the snowmobile to a complete halt.

CAUTION: Do not apply throttle and brake at the same time.

3) Ignition Switch

The lights come ON automatically whenever the engine is running.

Manual Starting

Key operated, 2-position switch. To start the engine, first turn the key to ON position then, follow STARTING PROCEDURE. To stop the engine, turn the key to OFF position.

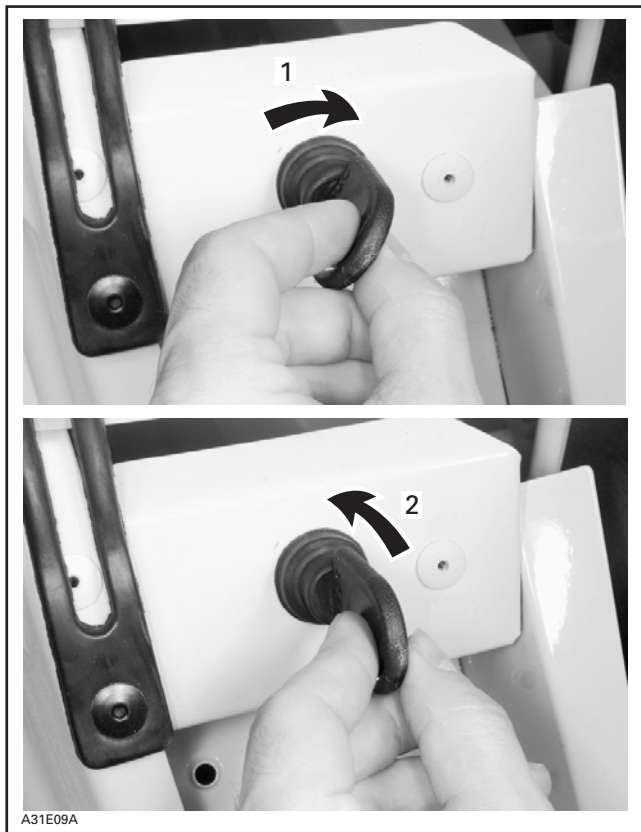

1. ON
2. OFF

4) Tether Cut-Out Switch

When the tether cord is pulled off its switch, the engine stops and prevents the snowmobile from running away if a throttle problem occurs or you fall off while riding. Always clip the tether cord to your clothing and the tether cut-out switch before starting the engine. Leave it attached during your ride.

WARNING

Do not remove disk from tether cord. This safety device will unplug tether cord cap if hood is lifted. Engine will automatically stop.

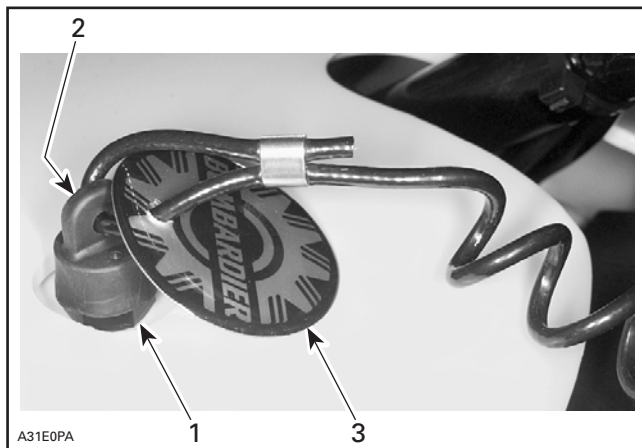

1. Tether cut-out switch
2. Tether cord cap
3. Do not remove this disk

5) Engine Cut-Out Switch

A 3-position type switch located on the right side of the handlebar. To stop the engine in an emergency, push the button to the front or rear OFF position and simultaneously apply the brake. To restart, button must be at middle ON position.

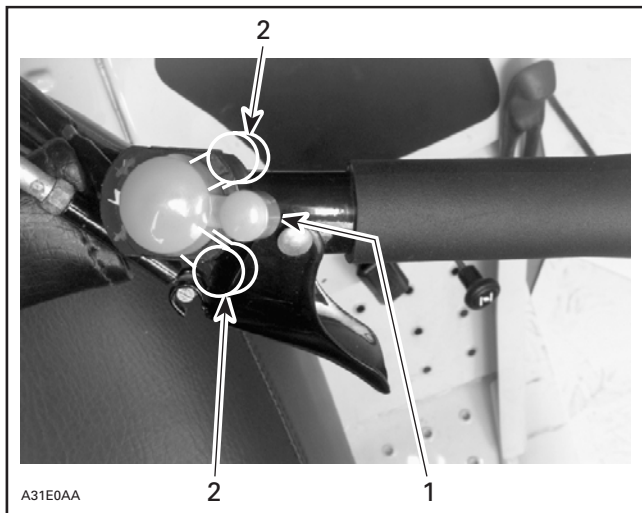

1. ON
2. OFF

6) Rewind Starter Handle

Auto-rewind type located on right hand side of snowmobile. To engage mechanism, pull handle slowly until a resistance is felt then pull vigorously. Slowly release handle.

7) Choke Button

This device features a multi-position button to facilitate cold start.

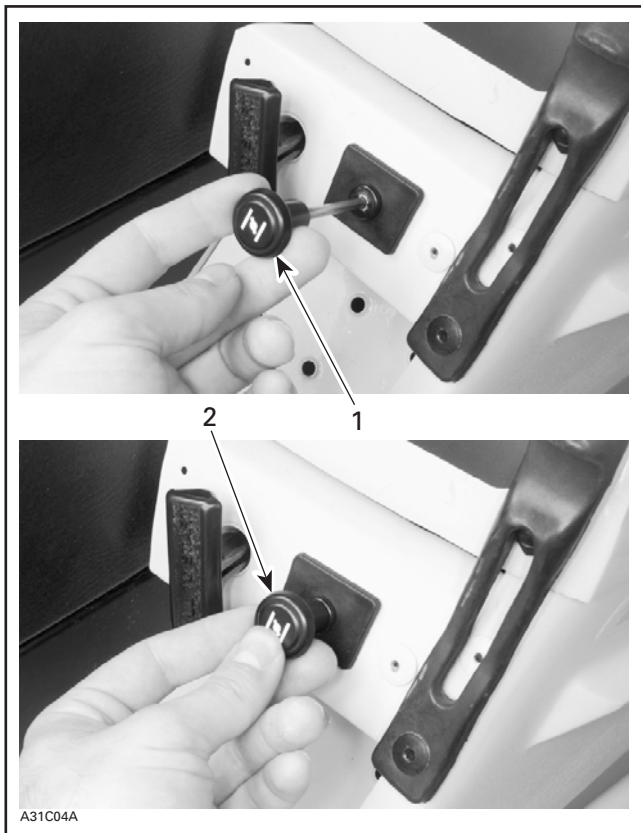

1. Cold start
2. Warm start

8) Hood Latches

Hood latches are used to lock hood to its anchors.

BEFORE YOU START

Always do a pre-start inspection with your parents or adult before you turn on the ignition. Refer to PRE-OPERATION CHECK.

Throttle

Operate the throttle 2 or 3 times before you turn on the ignition. It must return freely to the idle or closed position, as shown.

WARNING

Throttle lever must operate easily and smoothly. It must return to idle position when released.



A31C09A

CORRECT THROTTLE POSITION BEFORE STARTING

Brake

Test your brake lever as you did the throttle.



CORRECT BRAKE LEVER POSITION BEFORE STARTING

Visual Inspection

Make certain hood is fastened with hood latches and remove any snow and ice buildup from lights, windshield and running boards.



LEFT SIDE SHOWN — HOOD LATCH IN FASTENING POSITION

Track

Make sure the track is not frozen to the ground. To verify, lift rear of snowmobile or ask an adult to help.



LIFTING REAR OF SNOWMOBILE

WARNING

Never lift snowmobile if engine is running.

HOW TO START

Never attempt to start the engine unless the throttle returns to its normal or idle position. Verify this **before** starting. Keep hands off of throttle when actually starting.

Put on your safety helmet and attach tether cord to your clothing.



A31A05A

TETHER CORD ATTACHED TO CLOTHING

Connect tether cord cap to snowmobile switch.



TETHER CORD CAP CONNECTED TO SWITCH

Turn the ignition key to the ON position.

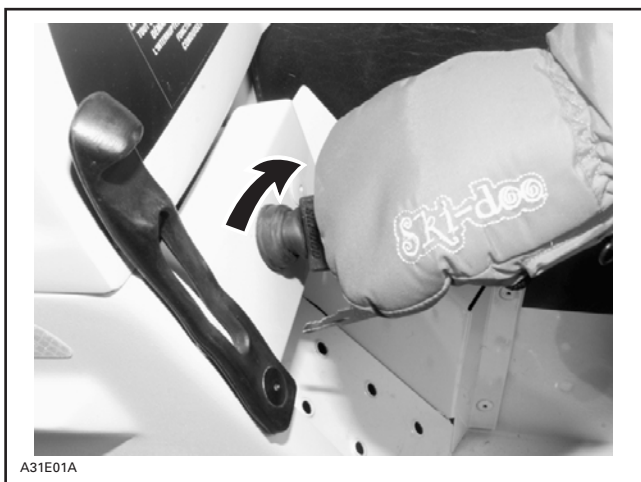

IGNITION KEY TO THE ON POSITION

Set engine cut-out switch to middle position.



A31E02A

ENGINE CUT-OUT SWITCH TO MIDDLE POSITION

Engage choke only if the engine is cold.



A31C0EA

CHOKE IS ENGAGED FOR COLD ENGINE STARTING

Pull starter handle to start engine.

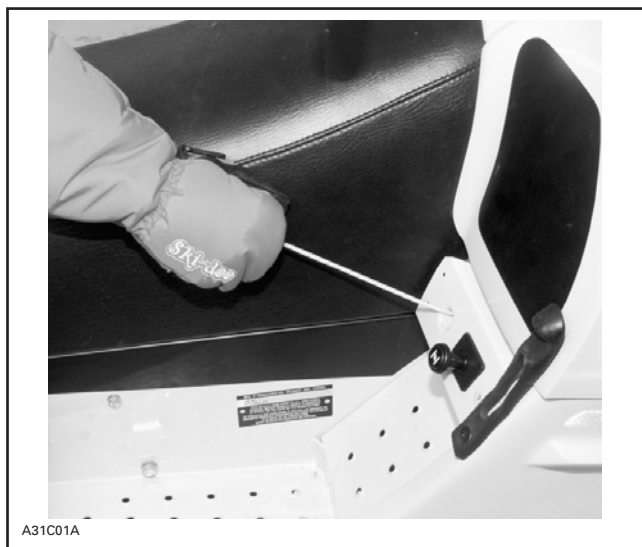

STARTER HANDLE IS PULLED

Allow engine to warm then disengage choke before operating at full throttle.

While the engine is warming, check the headlight and the taillight, then set the engine cut-out switch to both extreme positions to be certain it will stop the engine. Before restarting your snowmobile, recheck the throttle control and be sure the vehicle is headed away from people or objects. Now re-start your engine again.

HOW TO STOP

Before riding your snowmobile, you should understand how to stop it. Release the throttle and gradually depress the brake lever on the left side of the handlebar and then turn the ignition key to the OFF position.



TURNING IGNITION KEY TO STOP ENGINE

EMERGENCY STOP

In an emergency, you may stop your vehicle by turning the engine cut-out switch located near the throttle control and applying the brake.

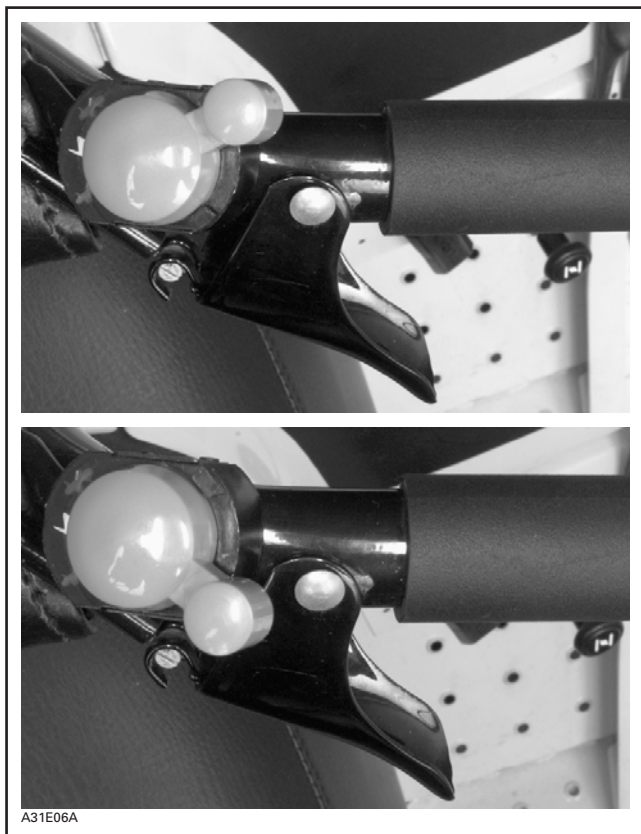

BOTH OFF POSITIONS FOR EMERGENCY STOP

Remember, a snowmobile cannot “stop on a dime”. Braking characteristics vary with deep snow, packed snow or ice. If the track is locked during hard braking, skidding may result.

FIRST RIDE

Under adult supervision, select an open snow covered area which is free of hazards.

Push on throttle lever while holding on to handlebar.



TO ACCELERATE

Practice riding by using throttle lever to accelerate then brake lever to brake.



TO BRAKE

Go slowly and avoid all obstacles.

HOW TO RIDE

Your riding position and balance are the 2 basic principles of making your snowmobile go where you want it to.

These are 3 ways to position your body while riding the snowmobile; sitting, kneeling or standing.

Sitting



FEET ON THE RUNNING BOARDS, KNEES AND HIPS FLEXIBLE



A31H0HA

WRONG

Kneeling



A31H03A

ONE FOOT ON THE RUNNING BOARD AND THE OPPOSITE KNEE ON THE SEAT

Standing



BOTH FEET ON THE RUNNING BOARD WITH KNEES FLEXED

WARNING

Be watchful of any overhead branches or other hazards.

Passenger

This vehicle is intended for one operator only, no passenger.



WRONG

People at Front

Make certain your snowmobile is pointed away from people or objects before you start it. No one is to be standing in front of or in back of the snowmobile.



BAD

SIGNALS

WARNING

Always be careful of other snowmobiles ahead or near you.
Stop or steer away from others.

If you intend to stop, raise either hand straight above your head. A left turn is indicated by extending your left hand straight out in the proper direction. For right turns, extend the left arm and raise the hand to a vertical position so it forms a right angle at the elbow.

Stop



A31H05A

TO INDICATE STOP

Left Turn



A31H06A

TO INDICATE LEFT TURN

Right Turn



A31H07A

TO INDICATE RIGHT TURN

AFTER USE

When you return from your ride, stop the engine and remove the tether cord. Talk to your parents or the owner of the snowmobile about your ride.

Remember, always drive carefully with your snowmobiling.

PARENT'S SECTION

HOW TO IDENTIFY YOUR SNOWMOBILE

The main components of the snowmobile (engine and frame) are identified by different serial numbers. It may sometimes become necessary to locate these numbers for warranty purposes or to trace your snowmobile in the event of loss. These numbers are required by the authorized SKI-DOO dealer to complete warranty claims properly. No warranty will be allowed by Bombardier Inc. if the engine serial number or Vehicle Identification Number (VIN) is removed or mutilated in any way. We strongly recommend that you take note of all the serial numbers on your snowmobile and supply them to your insurance company.

Vehicle Identification Number Location



TYPICAL

1. Vehicle identification number

Engine Serial Number Location

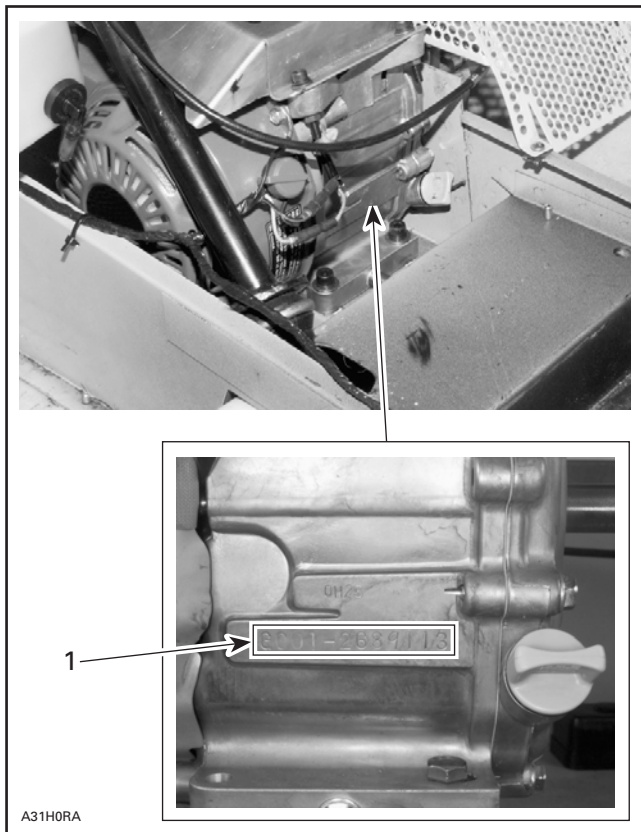

1. Engine serial number

ON-VEHICLE IMPORTANT INSTRUCTIONS

Please read the following instructions carefully before operating snow-mobile.

Chain Guard



Hood (above footrest)

▲ WARNING

This snowmobile is classified as a children's snowmobile, group 1. It is not designed to exceed speeds of eight (8) m/hr (12.9 Km/hr), nor to carry passenger(s), cargo, pull a sleigh, toboggan or any object of similar nature.

Children should only be allowed to use the snowmobile in the presence or under the supervision of an adult. It is recommended that children using this snowmobile be not less than six (6) years of age.

Use of snowmobile should be limited to daylight operation, in areas clear of obstacles, on adequate snow covered terrain, and not on frozen bodies of water, snowmobile or ATV trails or near streets or roadways.

Test the throttle lever operation each time before starting the engine.

Securely attach the safety lanyard to the child's body prior to the start of the engine.

Always make sure children wear all appropriate protective clothing, including an approved safety helmet, with goggles.

Always comply with these instructions on proper use, carefully read the operator's guide and safety handbook and observe safe and responsible riding.

516 001 218

▲ AVERTISSEMENT

Cette motoneige est classifiée comme une motoneige pour enfant, groupe 1. Elle n'est pas conçue pour excéder des vitesses de plus de 12.9 Km/hr (8 m/hr), ni pour transporter des passager(s), des charges, tirer un traîneau, toboggan ou appareils de nature similaire.

L'utilisation de la motoneige par un enfant ne peut se faire qu'en présence ou sous la supervision d'adultes. Il est recommandé qu'aucun enfant de moins de six (6) ans n'utilise cette motoneige.

La motoneige devrait être utilisée seulement que le jour, dans des zones libres d'obstacles, sur une surface adéquatement enneigée, et non sur des surfaces d'eau gelées, pistes de motoneiges ou de VTT, ni près des routes ou chemins.

Avant de démarrer le moteur, assurez-vous que la manette d'accélérateur fonctionne librement.

Fixez adéquatement le cordon de sécurité à l'enfant avant de mettre en marche le moteur.

L'enfant doit toujours porter les vêtements et accessoires de protection appropriés, incluant un casque de sécurité approuvé, avec lunettes.

Conformez-vous toujours avec ces consignes sur l'utilisation appropriée, lisez attentivement les guides du conducteur et de sécurité et conduisez prudemment.

516 001 217

FUEL AND OIL

Recommended Fuel

Use regular unleaded gasoline, available from most service stations or oxygenated fuel containing less than 10% of ethanol or 5% of methanol. The gasoline used must have an octane number (R + M)/2 of 86 or higher.

NOTE: In most service stations pump octane number corresponds to (R + M)/2 octane number.

Fuel System Antifreeze

When using oxygenated fuel, additional gas line antifreeze or water absorbing additives are not required and should be not used.

When using non-oxygenated fuel, we highly recommend the use of isopropyl base gas line antifreeze in a proportion of 150 mL (5 U.S. oz) of gas line antifreeze added to 40 liters (10-1/2 U.S. gal) of gas.

This precaution is in order to reduce the risk of frozen carburetor(s) which may lead, in certain cases, to high fuel consumption or severe damage to engine.

NOTE: Use only **methyl hydrate free** gas line antifreeze, Kleen-Flo* or equivalent.

CAUTION: Never mix oil with fuel. This snowmobile has a 4-cycle engine. Oil must be added to engine base only.

CAUTION: Never experiment with other fuels. The use of unrec-ommended fuel can result in snowmobile performance deterioration and damage to critical parts in the fuel system and engine components.

WARNING

Never top up the fuel tank before placing the snowmobile in a warm area. As temperature increases, fuel expands and might overflow. Fuel is flammable and explosive under certain conditions. Always wipe off any fuel or oil spillage from the snowmobile.

⚠ WARNING

Do not allow children to refuel the snowmobile.



A31A02A

WRONG

Recommended Oil

Always maintain oil engine level with 4-stroke engine oil that meets or exceeds the requirements for API service classification SF or SG. Always check the API service label on the oil container to be sure it includes the letters SF or SG.

SAE 5W30 is recommended for general, all temperature use.

Other viscosities shown in the chart may be used when the average temperature in your area is within the indicated range.

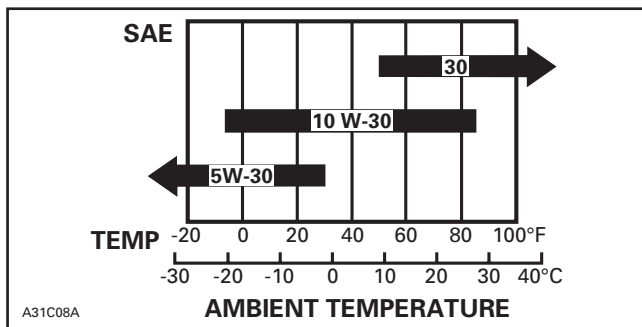

Engine Oil Level

NOTE: This should only be done by an adult.

With snowmobile on a level surface, check the oil level by removing dipstick at engine base. Oil level must be to the top of the oil filler neck. If not, refill up to oil filler neck using SAE 5W30 recommended for general use.

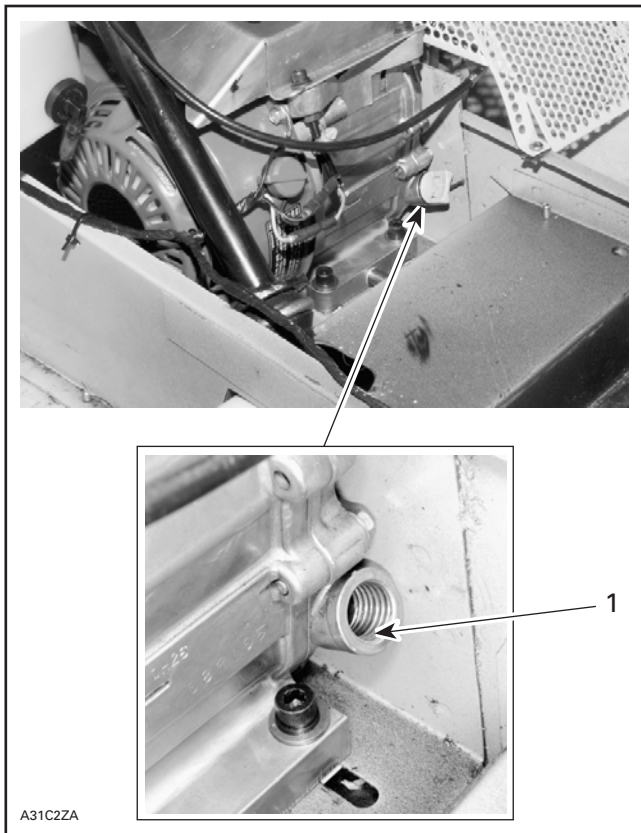

CHECKING OIL LEVEL

1. Top of the oil filler neck

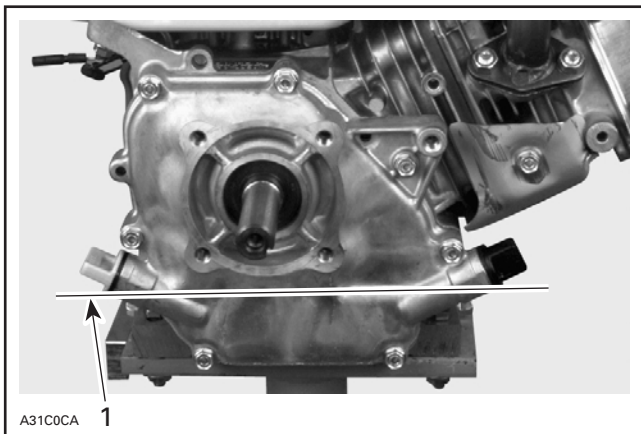

1. Proper oil level

WARNING

Check level and refill every time you refuel. Do not overfill.
Wipe off any spillage.

BREAK-IN PERIOD

Engine

A break-in period of 10 operating hours is required before running the snowmobile at full throttle.

CAUTION: Never mix fuel and oil. This snowmobile is equipped with a 4-cycle engine.

During this period, maximum throttle should not exceed 3/4. However, brief full acceleration and speed variations contribute to a good break-in.

CAUTION: Continued wide open throttle accelerations, prolonged cruising speeds and engine overheating are detrimental during the break-in period.

Always remove and clean spark plug after engine break-in.

10-Hour Inspection

As with any precision piece of mechanical equipment, we suggest that after the first 10 hours of operation or 30 days after the purchase, whichever comes first, your snowmobile be checked by an authorized SKI-DOO dealer. This inspection will give you the opportunity to discuss the unanswered questions you may have encountered during the first hours of operation.

The 10-hour inspection is at the expense of the snowmobile owner.

PRE-OPERATION CHECK

WARNING

The pre-operation check is very important prior to operating the vehicle. Always check the proper operation of critical controls, safety features and mechanical components before starting. If not done as specified here, severe injury or death might occur.

Verify that skis, track and idler wheels are unfrozen and free to turn.

WARNING

Never lift snowmobile if engine is running.

- Activate the brake control lever and make sure the brake fully applies before the brake control lever touches the handlebar grip. It must fully return when released. Refer to **Brake Adjustment**.
- Activate the throttle control lever several times to check that it operates easily and smoothly.

WARNING

Throttle lever must operate easily and smoothly. It must return to idle position when released.

- Clean then check operation of headlight switch (HI-LO), taillight, and tether and engine cut-out switches.
- Verify that skis and steering operate freely. Check corresponding action skis versus handlebar. There should be no excessive play in the steering linkage or connections to the skis. Remove accumulated ice and snow from underneath the hood.
- Check fuel and engine oil for levels and leaks. Replenish as necessary (**to be done by an adult only**). See an authorized SKI-DOO dealer in case of any leaks.
- Check for drive chain excessive wear. Have vehicle repaired.
- Make certain hood is fastened with hood latches and remove any snow and ice buildup from lights, windshield and running boards.
- Check weather forecast: Will you be warm enough?
- Make certain your snowmobile is pointed away from people or objects before you start it. No one is to be standing in front of or in back of the snowmobile.
- Ensure fuel shut-off valve is in fully open position. Fuel shut-off valve is located on carburetor in engine compartment.

PRE-OPERATION CHECK LIST

ITEM	OPERATION	✓
Track and idler wheels	Check for free movement.	
Brake lever	Check proper action.	
Throttle lever	Check proper action.	
Switches and lights	Check proper action. Tether cord must be attached to driver clothing.	
Skis and steering	Check for free movement and proper action.	
Fuel and oil	Check for proper level and leaks.	
Fuel shut-off valve	Check for fully open position.	
Drive chain	Check for proper condition.	
Vehicle vicinity	Snowmobile must be pointed away from people or objects. No one is to be standing in front of or in back of the snowmobile.	
Hood fastening	Check for proper latching.	
Clothing	Be warmly dressed according to weather forecast.	

STARTING PROCEDURE

- Re-check throttle operation.
- Ensure that the engine cut-out switch is in the ON position.
- Ensure the tether cut-out cap is in position and that the cord is attached to child clothing.
- Check that tether cord disk is in place and in good condition. This disk will unplug tether cord and stop engine if children try to open hood while engine is running. Refer to **Tether Cut-Out Switch**.
- Set choke button to ON or OFF position, depending of the weather. Refer to **Choke Button**.

Manual Starting

Insert the key in the ignition switch and turn to ON position.

Grasp manual starter handle firmly and crank engine.

WARNING

Do not apply throttle while starting.

WARNING

Do not allow children to refuel the snowmobile.

REPAIR AND MAINTENANCE

NOTE: All maintenance should be done by an adult or an authorized SKI-DOO dealer and according to these directions as well as the LUBRICATION AND MAINTENANCE CHART.

Do not allow children to lift hood to attempt repairs or maintenance.



WRONG

WARNING

Engine and its components may be hot.

WARNING

It is recommended that the assistance of an authorized SKI-DOO dealer be periodically obtained on other components/systems not covered in this guide. Unless otherwise specified, engine must be cold and not running. The tether cord cap must be removed for all maintenance procedures.

Vehicle Cleaning and Protection

Remove any dirt or rust.

To clean the entire vehicle, use only flannel cloths or equivalent.

CAUTION: It is necessary to use flannel cloths or equivalent on windshield and hood to avoid damaging further surfaces to clean.

To clean the entire vehicle, including bottom pan and metallic parts use Bombardier Cleaner (P/N 293 110 001 (spray can 400 g) and P/N 293 110 002 (4 L)) or an equivalent product.

CAUTION: Do not use Bombardier Cleaner on decals or vinyl.

For vinyl and plastic parts use Vinyl & Plastic Cleaner (P/N 413 711 200 (6 x 1 L)) or an equivalent product.

To remove scratches on windshield or hood use BOMBARDIER Scratch Remover Kit (P/N 861 774 800) or an equivalent product.

CAUTION: Never clean plastic parts or hood with strong detergent, degreasing agent, paint thinner, acetone, products containing chlorine, etc.

Inspect the hood and repair any damage.

Touch up all metal spots where paint has been scratched off. Spray all metal parts with BOMBARDIER LUBE (P/N 293 600 016) or an equivalent product.

Wax the hood and the painted portion of the frame for better protection.

NOTE: Apply wax on glossy finish only. Protect the vehicle with a cover to prevent dust accumulation during storage.

CAUTION: The snowmobile has to be stored in a cool and dry place and covered with an opaque tarpaulin. This will prevent sun rays and grime from affecting plastic components and vehicle finish.

Lift rear of vehicle until track is clear of the ground. Install on a snowmobile mechanical stand.

NOTE: Do not release track tension.

Chain Guard Removal and Installation

Open hood. Remove chain guard retaining screws and lift off the guard.

WARNING

When removing chain guard, ensure that engine is not running.

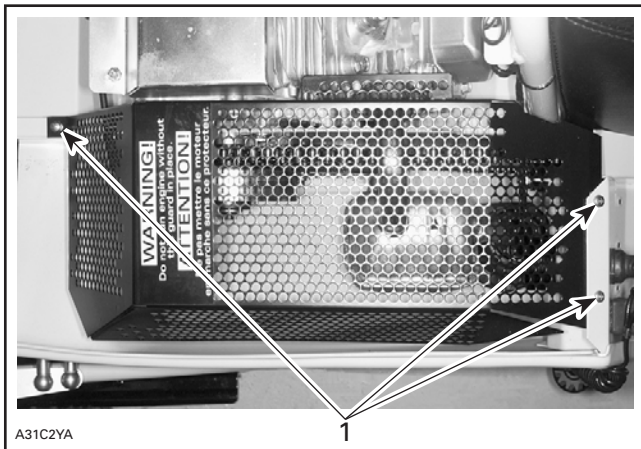

CHAIN GUARD

1. Retaining screws

Clutch Axle and Drive Chain Lubrication

Clutch Axle Lubrication

Remove chain guard.

Find connecting link then, separate chain. Remove chain from clutch sprocket.

NOTE: Do not remove chain from driven sprocket. Chain may be difficult to reinstall.

Remove clutch retaining screw and slide out the clutch.

Put clutch on a bench and drip a few drops of oil into clutch sleeve, as shown in the next illustration.

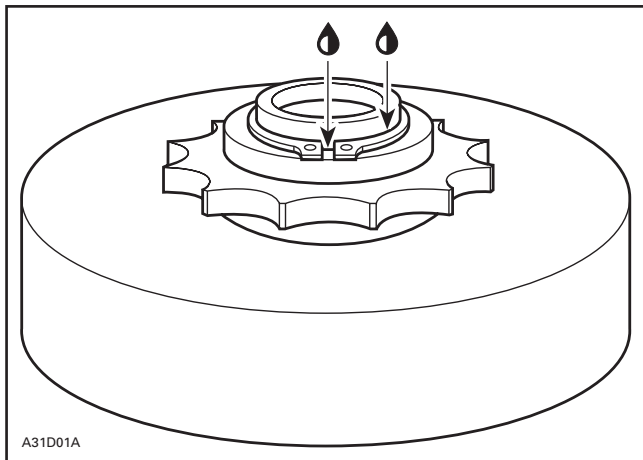

CLUTCH LUBRICATION

Reinstall clutch. Torque retaining screw to 23 N•m (17 lbf•ft).

Join both drive chain ends using connecting link.

Secure connecting link using outer link and circlip.

Install circlip so that open end is positioned opposite side of drive chain rotation. See the following illustration.

WARNING

Always ensure that connecting link, outer link and circlip are in good condition. Ensure that circlip is properly secured.

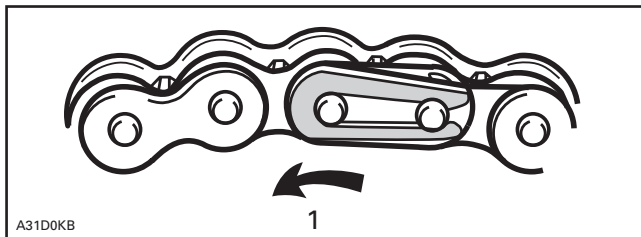

TYPICAL

1. Rotation

Drive Chain Lubrication

With chain properly installed on both sprockets, spray aerosol chain oil over the chain.

CAUTION: Always lubricate drive chain slightly. Oil must not contact brake pads.

Drive Chain Tension

Snowmobile is equipped with an automatic tensioner. Ensure that tensioner spring is not damaged.

Brake Condition

The brake mechanism on the snowmobile is an essential safety device. Keep this mechanism in proper working condition. Above all, do not operate the snowmobile without an effective brake system. Periodically verify the condition/wear of the brake pads.

Brake Adjustment

Fully apply brake with brake lever. If brake lever is not within 15 to 20 mm (19/32 to 25/32 in) of the handlebar, readjust brake.

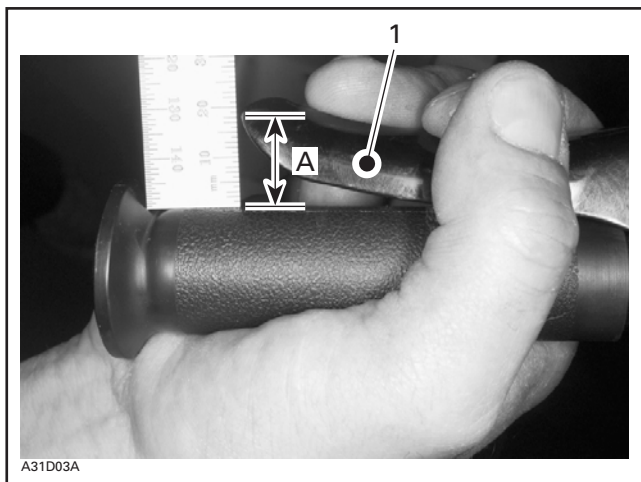

1. Brake lever

A. 15 to 20 mm (19/32 to 25/32 in)

To adjust brake, loosen Allen screw then pull on brake cable.

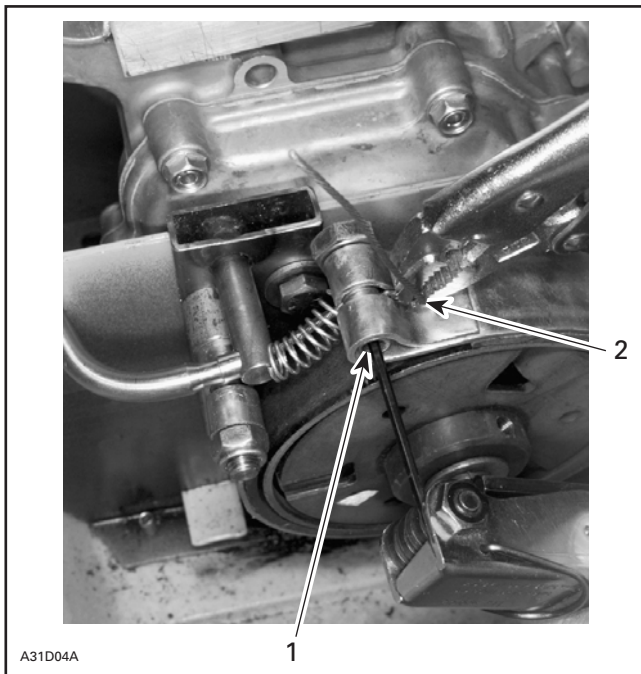

1. Loosen Allen screw
2. Pull brake cable with pliers

Retighten Allen screw.

WARNING

Always reinstall chain guard. Do not operate engine with hood opened or chain guard removed. Improper servicing, modification or poor adjustment may affect sprockets performance and life. Always obtain authorized SKI-DOO dealer advice before servicing or modifying the drive or driven sprockets. Always respect maintenance schedules.

Rear Suspension Condition

Visually inspect all suspension components including slider shoes, springs, wheels, etc.

NOTE: During normal driving, snow will act as a lubricant and coolant for the slider shoes. Extensive riding on ice or sanded snow, will create excessive heat build-up and cause premature wear of slider shoes.

Suspension Stopper Straps Condition

Inspect stopper straps for wear and cracks, bolts and nuts for tightness. If loose inspect holes for deformation. Replace as required. Torque nut to 9 N•m (80 lbf•in).

Track Condition

Lift the rear of the snowmobile and support it off the ground. With the engine off, rotate the track by hand, and inspect condition. If worn or cut, or if track fibers are exposed, or if missing or defective inserts or guides are noted; contact an authorized SKI-DOO dealer.

WARNING

Do not operate or rotate a track if torn, damaged or excessively worn.

Track Tension and Alignment

Tension

NOTE: The snowmobile should be ridden in snow about 15 to 20 minutes prior to adjusting track tension.

Lift rear of snowmobile and support it with a **snowmobile mechanical stand**.

Allow the suspension to extend normally and check gap 60 mm (2-3/8 in) from rear idler wheel bracket. The gap should be as given in SPECIFICATIONS. If the track tension is too loose, track will have a tendency to thump.

NOTE: A belt tension tester (P/N 414 348 200) may be used to measure deflection as well as force applied.

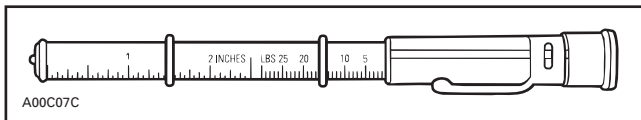

BELT TENSION TESTER

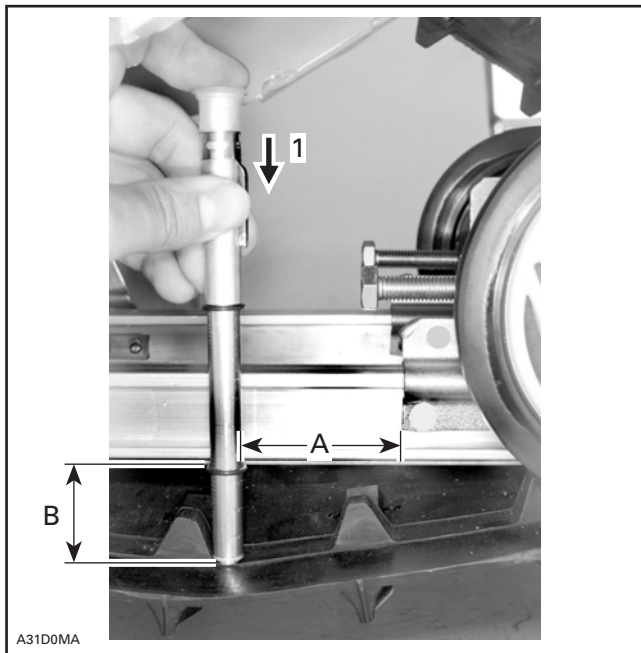

1. 7.3 kg (16 lb)

A. 60 mm (2-3/8 in)

B. 35 mm (1-3/8 in)

CAUTION: Too much tension will result in power loss and excessive stresses on suspension components.

To adjust tension:

- Loosen the rear idler wheel retaining screws.
- Loosen the lock nuts then turn adjustment screws to adjust.

If correct tension is unattainable, contact an authorized SKI-DOO dealer.

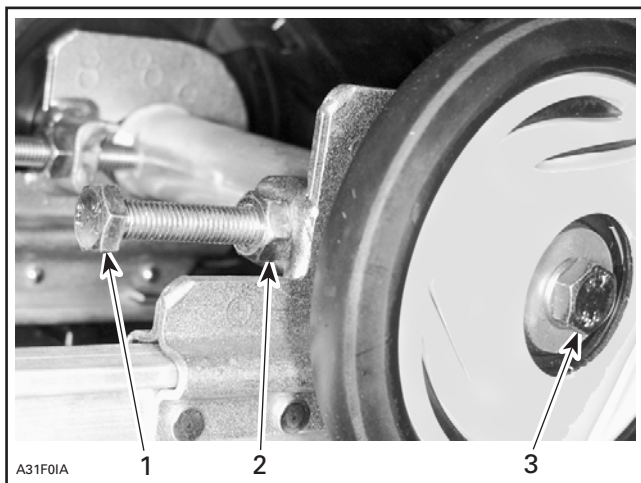

1. Adjustment screw
2. Loosen lock nut
3. Loosen screw

Alignment

NOTE: Track tension and alignment are interrelated. Do not adjust one without the other.

WARNING

Before checking track alignment, ensure that the track is free of all particles which could be thrown out while track is rotating. Keep hands, tools, feet and clothing clear of track. Ensure no one is standing in close proximity to the snowmobile.

Start the engine and accelerate slightly so that track barely rotates. This must be done in a short period of time (15 to 20 seconds). Check that the track is well centered; equal distance on both sides between edges of track guides and slider shoes.

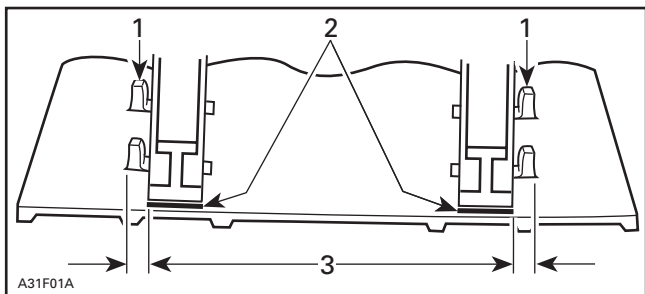

TYPICAL

1. Guides
2. Slider shoes
3. Equal distance

To correct, **stop the engine**: Loosen the lock nuts and tighten the adjustment screw on side where the slider shoe is the farthest from the track guides.

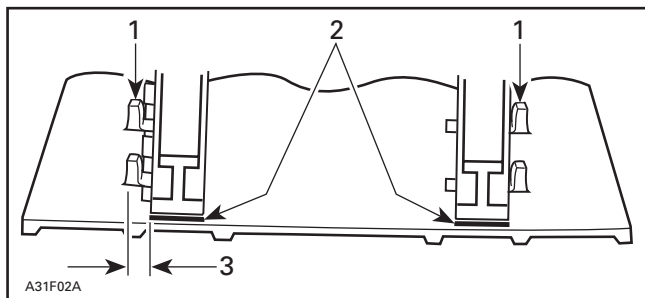

TYPICAL

1. Guides
2. Slider shoes
3. Tighten on this side

Tighten lock nuts and rear idler wheel retaining screws.

WARNING

If lock nuts or retaining screws are not tightened properly, the adjusting screws could loosen causing the track to become extremely loose and, under some operating conditions, allow the idler wheels to climb over the track lugs forcing the track against the tunnel causing the track to “lock”.

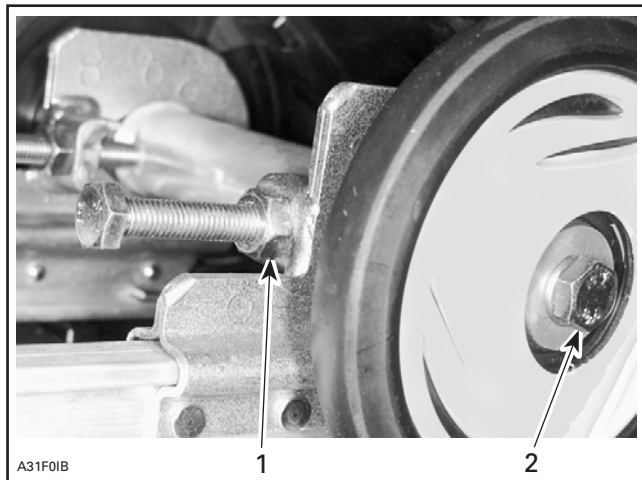

1. *Retighten lock nuts*
2. *Retighten rear idler wheel retaining screws*

Restart engine and rotate track slowly to recheck alignment.

Reposition snowmobile on the ground.

Steering and Front Suspension Mechanism

Visually inspect steering and front suspension mechanism for tightness of components (steering arms, control arms and links, tie rods, ball joints, ski coupler bolts, etc.). If necessary, contact an authorized SKI-DOO dealer.

Wear and Condition of Skis and Runners

Check the condition of the skis and ski runners. If worn, contact an authorized SKI-DOO dealer.

WARNING

Excessively worn skis and/or ski runners will affect snowmobile control.

Exhaust System

The tail pipe of the muffler should be centered with the exit hole in the bottom pan. It must be free of rust or leaks.

The exhaust system is designed to reduce noise and to improve the total performance of the engine. If any exhaust system component is removed from the engine, severe engine damage will result.

Bulb Replacement

Always check light operation after bulb replacement.

Headlight

If the headlight bulb is burnt, tilt hood.

Remove the rubber boot and turn bulb retainer ring counterclockwise.



A31E0BA

RUBBER BOOT AND BULB RETAINER REMOVAL

Pull off bulb retainer, detach the bulb and replace. Properly reinstall parts.



Taillight

Taillight is sealed. If it is burnt, replace taillight ass'y with new one.

To remove, unscrew the 2 lens screws.

Pull out taillight ass'y.

Unplug connector.

Install new taillight ass'y.

STORAGE AND PRESEASON PREPARATION

Storage

It is during summer, or when a snowmobile is not in use for more than one month that proper storage is a necessity.

To prepare your snowmobile, refer to an authorized SKI-DOO dealer.

CAUTION: Do not run engine during storage period.

Preseason Preparation

Refer to an authorized SKI-DOO dealer.

CAUTION: Have carburetor cleaned-up before restarting engine.

TROUBLESHOOTING

NOTE: All troubleshooting should be done by an adult or by an authorized SKI-DOO dealer.

SYMPTOM: <i>Engine turns over but fails to start.</i>	
POSSIBLE CAUSES	WHAT TO DO
1. Ignition switch, engine cut-out switch or tether switch is in the OFF position.	Place all switches in the RUN or ON position.
2. Mixture not rich enough to start cold engine.	Check fuel tank level and check starting procedure, particularly use of the choke.
3. Flooded engine (spark plug wet when removed).	Do not choke. Remove wet spark plug, turn ignition switch to OFF and crank engine several times. Install clean dry properly gapped spark plug. Start engine following usual starting procedure. If engine continues to flood, see an authorized SKI-DOO dealer.
4. No fuel to the engine (spark plug dry when removed).	Check fuel tank level; turn fuel valve on, check condition of fuel and impulse lines and their connections. Check carburetor cleanliness and adjustments. Contact an authorized SKI-DOO dealer.
5. Spark plug/ignition (no spark).	Remove spark plug then reconnect to spark cap. Check that engine cut-out switch is at the ON position and the tether cut-out switch cap is snapped over the receptacle. Start engine with spark plug grounded to engine away from spark plug hole. If no spark appears, replace spark plug with a new one properly gapped. If trouble persists, contact an authorized SKI-DOO dealer.

SYMPTOM: Engine lacks acceleration or power.

POSSIBLE CAUSES	WHAT TO DO
1. Fouled or defective spark plug.	Check item 5 of "Engine turns over but fails to start".
2. Lack of fuel to engine.	Check item 4 of "Engine turns over but fails to start".
3. Carburetor adjustments.	Contact an authorized SKI-DOO dealer.
4. Clutch requires servicing.	Contact an authorized SKI-DOO dealer.
5. Engine is overheating.	Clean cooling fins of engine; if overheating persists, contact an authorized SKI-DOO dealer.

SYMPTOM: Engine backfires.

POSSIBLE CAUSES	WHAT TO DO
1. Faulty spark plug (carbon accumulation) or wrong gap.	See item 5 of "Engine turns over but fails to start".
2. Engine is running too hot.	See item 5 of "Engine lacks acceleration or power".
3. Ignition timing is incorrect or there is an ignition system failure.	Contact an authorized SKI-DOO dealer.

SYMPTOM: Engine misfires.

POSSIBLE CAUSES	WHAT TO DO
1. Fouled/defective/worn spark plug or wrong gap.	Clean/verify spark plug gap and heat range. Replace as required.
2. Water in fuel.	Drain fuel system and refill with fresh fuel.

SYMPTOM: Snowmobile cannot reach full speed.

POSSIBLE CAUSES	WHAT TO DO
1. Incorrect track adjustment.	See REPAIR AND MAINTENANCE and/or dealer for proper alignment and tension adjustments.
2. Engine.	See items 1, 2 and 5 of "Engine lacks acceleration or power".

SPECIFICATIONS

GENERAL		MINI Z
ENGINE		
- Maximum power engine speed	RPM	4000
DRIVE CHAIN		
- Pitch	mm (in)	12.7 (0.500)
- Number of links		78
SPARK PLUG		
- Type		NGK BPR6 ES
- Gap	mm (in)	0.7 - 0.8 (0.028 - 0.031)
TRACK		
- Tension	mm (in)	35 (1-3/8) ①
- Alignment		②
FLUIDS		
FUEL		
- Type		③
- Tank capacity	L (U.S. gal)	1.8 (0.5)
OIL (ENGINE)		
- Type		④
- Capacity	L (U.S. oz)	0.6 (20.3)







Because of our ongoing commitment to product quality and innovation, Bombardier reserves the right, at any time, to make changes in design and specifications and/or to make additions to, or improvements in its products without imposing any obligation upon itself to install them on its products previously manufactured.





- ① Measure gap between slider shoe and bottom inside of track when exerting a downward pull of 7.3 kg (16 lb) to the track.
- ② Equal distance between edges of track guides and slider shoes.
- ③ Regular unleaded gasoline with a minimum octane number of 86 (R + M)/2.
- ④ SAE 5W-30 4-stroke motor oil.

LUBRICATION AND MAINTENANCE CHART

Refer to LUBRICATION AND MAINTENANCE in *Shop Manual* for more details.

- ① 10-HOUR INSPECTION
(to be performed by an authorized SKI-DOO dealer)
- ② WEEKLY
- ③ MONTHLY
- ④ ONCE A YEAR
- ⑤ STORAGE (to be performed by dealer)
- ⑥ PRESEASON PREPARATION (to be performed by dealer)

LUBRICATION AND MAINTENANCE CHART		①	②	③	④	⑤	⑥
	Starting rope condition						✓
	Engine head nuts	✓			✓		
	Engine mount nuts	✓			✓		
	Exhaust system	✓		✓			✓
	Engine lubrication					✓	
	Cooling system condition	✓			✓		✓
	Condition of seals						✓
	Valve clearance				✓		
	Oil level	EACH USE					
	Oil change	✓	6 months/100 hrs.				
	Fuel filter replacement						✓
	Fuel lines and connections	✓					✓
	Carburetor adjustment	✓			✓		✓
	Carburetor cleaning						✓
	Throttle cable inspection	✓			✓		✓
	Condition of drive and driven sprockets	✓		✓		✓	✓
	Lubrication of clutch and chain	✓		✓		✓	✓
	Retorquing of clutch retaining screw	✓		✓		✓	✓
	Brake condition	✓	✓				✓
	Brake adjustment			✓			✓

LUBRICATION AND MAINTENANCE CHART		①	②	③	④	⑤	⑥
	Drive chain tension	✓		✓			
	Lubrication of drive axle and bearing			✓		✓	
	Steering and front suspension mechanism	✓		✓		✓	✓
	Wear and condition of skis and runners	✓	✓				
	Suspension lubrication			✓		✓	
	Suspension condition	✓			✓		✓
	Suspension stopper straps condition				✓		✓
	Track condition	✓		✓			✓
	Track tension and alignment	✓	AS REQUIRED				
	Spark plug*	✓		✓			✓
	Engine timing	✓					✓
	Headlight beam aiming				✓		
	Wiring harnesses, cables and lines	✓		✓			
	Operation of lighting system (headlight and taillight), test operation of engine cut-out switch and tether cut-out switch	✓	✓				✓
	Rags in air intake and exhaust system					✓	✓
	Engine compartment	✓		✓			✓
	General inspection	✓		✓		✓	

* Before installing new spark plug at preseason preparation, it is suggested to burn excess storage oil by starting the engine with the old spark plug. Only perform this operation in a well ventilated area.

CHANGE OF ADDRESS OR OWNERSHIP

If your address or owner has changed, be sure to fill out and mail the card provided on next page.

Such notification is likewise necessary for your own safety even after expiration of the original warranty, since Bombardier will be in a position to contact you if correction to your snowmobile becomes necessary.

NOTICE TO ALL NEW OWNERS:

Mail the *Change of Ownership Card* as you are entitled to the unexpired portion of the warranty.

STOLEN UNITS

If the event that your snowmobile is stolen, you should notify an authorized SKI-DOO dealer and the Bombardier warranty department of such.

Please provide your name, address, phone number, vehicle serial number and date it was stolen.

Bombardier will provide a list of stolen units to all authorized SKI-DOO dealers on a monthly basis to aid in recovery of such units to their owners.



BOMBARDIER
RECREATIONAL PRODUCTS

AFFIX
PROPER
POSTAGE

BOMBARDIER
RECREATIONAL PRODUCTS
WARRANTY DEPARTMENT
75 J.A. BOMBARDIER ST.
SHERBROOKE (QUEBEC)
CANADA J1L 1W3

BOMBARDIER
RECREATIONAL PRODUCTS



© TMTrademarks of Bombardier Inc. or its subsidiaries.
© 2001 Bombardier Inc. All rights reserved.
Printed in Canada.

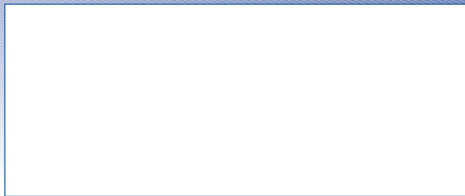

ski-doo
2002