

## **SERVICE TOOLS**

This is a list of tools to properly service Ski-Doo snowmobile models specified on cover page. The list includes both the mandatory tools and the optional tools that are ordered separately. The list of Service Products, both mandatory and optional, are not part of any kit and must all be ordered separately. If you need to replace or add to your tool inventory these items can be ordered through the regular parts channel.

## Section 01 SERVICE TOOLS AND SERVICE PRODUCTS

### Subsection 01 (SERVICE TOOLS)

## ENGINE — MANDATORY SERVICE TOOLS

Hose pincher (2)  
(P/N 295 000 076)

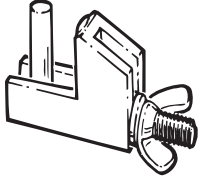

A01B2I4

#### APPLICATION

All vehicles.

Fluke multimeter  
(P/N 529 022 000)

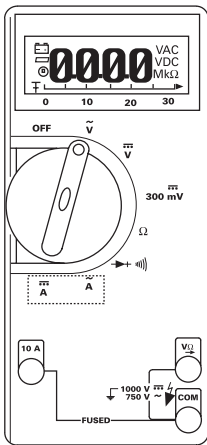

F01B1O4

#### APPLICATION

All models.

# Section 01 SERVICE TOOLS AND SERVICE PRODUCTS

## Subsection 01 (SERVICE TOOLS)

### ENGINE (continued) — RECOMMENDED SERVICE TOOLS

The following tools are highly recommended to optimize your basic tool kit and reduce repair time.

Circuit tester  
(continuity light)  
(P/N 414 012 200)

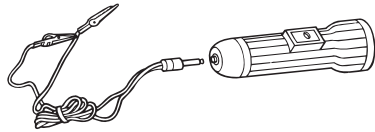

A00C214

**APPLICATION**  
All models.

Driver tool  
(P/N 529 035 521)

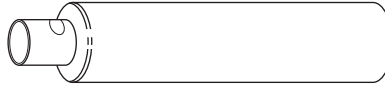

A00B404

**APPLICATION**  
Crankcase bearings.

Pilot 22 mm  
(P/N 529 035 523)

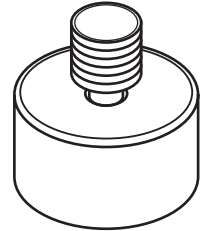

A00B404

**APPLICATION**  
Crankcase bearings.

Digital/induction type  
tachometer  
(P/N 529 014 500)

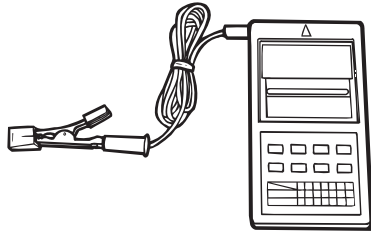

F01B1G4

**APPLICATION**  
All engines.

Attachment  
(P/N 529 035 522)

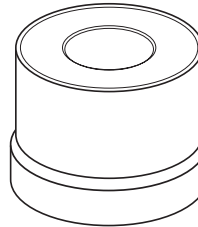

A00B4P4

**APPLICATION**  
Crankcase bearings.

Float level gauge  
(P/N 529 035 520)

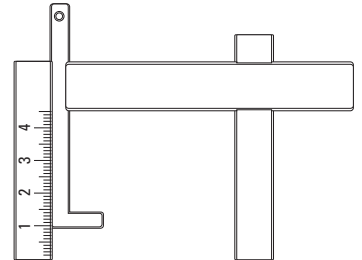

A00B4N4

**APPLICATION**  
All models.

---

## Section 01 SERVICE TOOLS AND SERVICE PRODUCTS

### Subsection 01 (SERVICE TOOLS)

---

#### TRANSMISSION — MANDATORY SERVICE TOOLS

Clutch holder  
(P/N 529 006 400)



A01B154

#### APPLICATION

All TRA drive pulleys and Mini Z fly-wheel.

Tension tester  
(P/N 414 348 200)



A03D1T4

#### APPLICATION

All models.

**TRANSMISSION (continued) — RECOMMENDED SERVICE TOOLS**

The following tools are highly recommended to optimize your basic tool kit and reduce repair time.

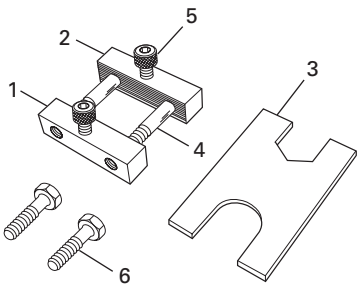
<p>Drive axle sprocket adjuster (P/N 861 725 700)</p>  <p>A01B204</p>
<p><b>APPLICATION</b> All vehicles.</p>
<p>Parts included in the kit:</p> <ul style="list-style-type: none"><li>1) Block with threads (P/N 529 010 700)</li><li>2) Block without threads (P/N 529 010 800)</li><li>3) Plate (P/N 529 010 600)</li><li>4) Bolt M10 (2) (P/N 222 007 565)</li><li>5) Allen screw M8 (2) (P/N 222 983 065)</li><li>6) Screw M8 (2) (P/N 222 082 565)</li></ul> <p><b>NOTE:</b> When the tool is to be use between tunnel and sprocket use screw M8.</p>

---

## Section 01 SERVICE TOOLS AND SERVICE PRODUCTS

### Subsection 01 (SERVICE TOOLS)

---

## SUSPENSION — RECOMMENDED SERVICE TOOLS

Track tension gauge  
(P/N 529 021 500)

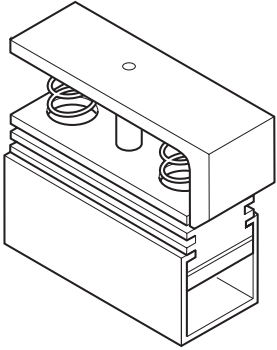

A00B3X4

#### APPLICATION

All models.

Drill bit  
(P/N 529 031 800)

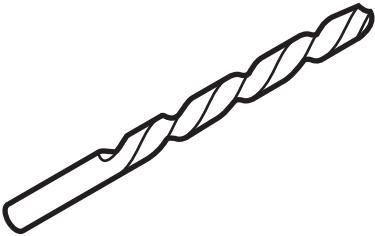

A01B564

#### APPLICATION

All 3/16 in rivets.

## Section 01 SERVICE TOOLS AND SERVICE PRODUCTS

### Subsection 01 (SERVICE TOOLS)

## VEHICLES — RECOMMENDED SERVICE TOOLS

Protective mat  
(P/N 529 030 600)

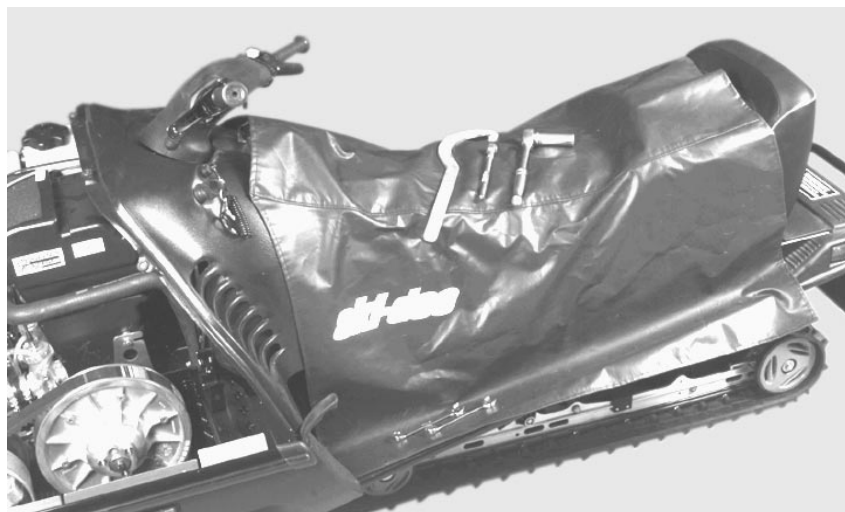

A01B45W

#### APPLICATION

All models.

Snowmobile jack  
(P/N 529 020 000)

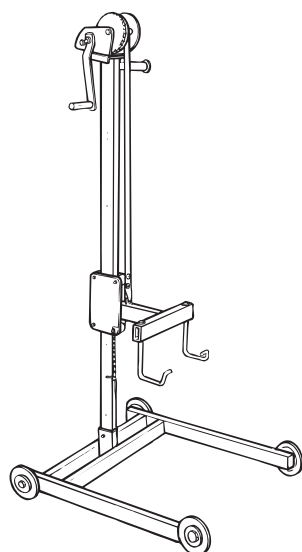

A01A1JJ

#### APPLICATION

All models.

# SERVICE PRODUCTS

## MANDATORY SERVICE PRODUCTS

Loctite® is a trademarks of Loctite Corporation.

Dow Corning® is a trademarks of Dow Corning Corporation.

Retaining compound  
(P/N 413 703 100)  
Loctite® RC/609:  
Retaining compound (10 mL)  
(green)



A00B2S4

### APPLICATION

Used for retaining bushings, bearings in slightly worn housing or on shaft.

Paste gasket  
(P/N 413 702 700)  
Loctite® 515:  
Gasket eliminator (50 mL)



A00B2T4

### APPLICATION

Crankcase halves and gearbox mating surfaces.

Medium-strength threadlocker  
(P/N 293 800 015)  
Loctite® 242:  
Threadlocker (10 mL)  
(blue, medium strength)



A00B324

### APPLICATION

Flywheel nut, crankcase studs, etc.  
**NOTE:** Loctite 242 will be replaced by Loctite 243 (P/N 293 800 060).

Sealing compound  
(P/N 420 297 905)



A00B564

### APPLICATION

To seal crankcase on all ZX series engines.

Paste gasket  
(P/N 293 800 038)  
Loctite® 518:  
Gasket eliminator (50 mL)



F01B124

### APPLICATION

Crankcase halves and gearbox mating surfaces.

High strength threadlocker  
(P/N 293 800 005)  
Loctite® 271:  
Threadlocker (10 mL)  
(red, high strength)



A00B2U4

### APPLICATION

Fasteners and studs up to 25 mm (1 in) diameter.



## Section 01 SERVICE TOOLS AND SERVICE PRODUCTS

### Subsection 02 (SERVICE PRODUCTS)

#### MANDATORY SERVICE PRODUCTS (continued)

Gasket/paint remover  
(P/N 413 708 500)

Loctite® Chisel  
510 g (18 oz)



A00B574

#### APPLICATION

Clean mating surfaces of cylinders and crankcase. Remove carbon in combustion chambers.

Loctite® primer  
(P/N 293 800 041)

Primer N  
170 g (6 oz)



A00B3N4

#### APPLICATION

To prepare mating surfaces before applying paste gasket, retaining compound or threadlockers.

**NOTE:** Only the P/N has been changed. This product is identical to the P/N 413 708 100.

Silicone compound  
(P/N 293 550 004)

Dow Corning® MS4



A00B3R4

#### APPLICATION

Lubricate pawl and pawl lock of re-wind starter.

**NOTE:** Only the P/N has been changed. This product is identical to the P/N 420 897 061.

Grease Isoflex  
(50 g)

(P/N 293 550 021)



A00B554

#### APPLICATION

To lubricate some bearings on 3-cylinder, 453, 493, 593 and 693 engines.

Petamo grease

(P/N 420 899 271)



A00B584

#### APPLICATION

To lubricate lip of all ZX series engine crankshaft seals.

## Section 01 SERVICE TOOLS AND SERVICE PRODUCTS

### Subsection 02 (SERVICE PRODUCTS)

## RECOMMENDED SERVICE PRODUCTS

Silicone dielectric grease  
(3 oz)  
(P/N 293 550 004)

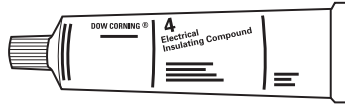

A00B1X4

### APPLICATION

On all electric connections. High tension coil and spark plug connections. Connector housings, etc.

**NOTE:** Only the P/N has been changed. This product is identical to the P/N 413 701 700.

Synthetic chaincase oil  
(12 x 355 mL)  
(P/N 413 803 300)



A01B4Q4

### APPLICATION

Chaincase lubricant on all liquid-cooled models and Skandic WT series.

Injection oil  
(P/N 413 802 900)  
(12 x 1 liter)  
(P/N 413 803 000)  
(3 x 4 liter)  
(P/N 413 803 200)  
(205 liter)



F01B2H4

### APPLICATION

All engines.

Grease LMZ no. 1  
(400 g)  
(P/N 413 707 500)



A00B1Y4

### APPLICATION

Mainly used between regulators or rectifiers and upper column to transfer the heat build-up and to assure a good ground.

Blizzard oil  
(12 x 500 mL)  
(P/N 413 803 100)

TYPICAL



A00B2Q4

### APPLICATION

All pre-mix models.

BOMBARDIER-ROTAX Formula  
XP-S synthetic injection oil  
(P/N 413 710 500)  
(12 x 1 liter)  
(P/N 413 711 000)  
(3 x 4 liter)  
(P/N 413 710 700)  
(205 liter)

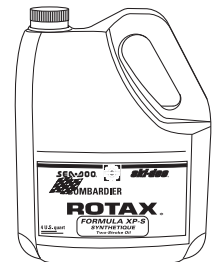

F01B354

### APPLICATION

All engines.

Chaincase oil  
(16 x 250 mL)  
(P/N 413 801 900)



A00B2R4

### APPLICATION

Chaincase lubricant on all fan-cooled models except Skandic WT series.

## Section 01 SERVICE TOOLS AND SERVICE PRODUCTS

### Subsection 02 (SERVICE PRODUCTS)

## RECOMMENDED SERVICE PRODUCTS (continued)

Pipe sealant  
(P/N 293 800 018)  
Loctite 592 (50 mL)



A00B2W4

#### APPLICATION

Engine plugs and senders.

**NOTE:** Only the P/N has been changed. This product is identical to the P/N 413 702 300.

High temperature threadlocker  
(P/N 413 711 400)  
Loctite 648 (green) (5 mL)



A00B3D4

#### APPLICATION

To fasten oil injection nozzle to crankcase.

**NOTE:** Only the P/N has been changed. This product is identical to the P/N 420 899 788.

Anti-seize lubricant  
(P/N 293 800 023)  
Loctite anti-seize  
lubricant 454 g (16 oz)



A00B594

#### APPLICATION

Unpainted surfaces of driven pulley countershaft.

Synthetic grease  
(400 g)  
(P/N 413 711 500)



A01B574

#### APPLICATION

For front and rear suspension components and drive axle bearing.

Storage oil  
(350 g spray can)  
(12 x 350 g)  
(P/N 413 711 600)

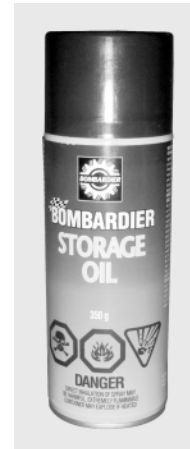

A02B054

#### APPLICATION

All models.

**NOTE:** Only the P/N has been changed. This product is identical to the P/N 496 014 100.

Degreaser  
(P/N 413 708 400)  
Permatex® 48 TA  
433 g (15 oz)



A00B3K4

#### APPLICATION

Engine, chaincase and any greasy surfaces.

## Section 01 SERVICE TOOLS AND SERVICE PRODUCTS

### Subsection 02 (SERVICE PRODUCTS)

## RECOMMENDED SERVICE PRODUCTS (continued)

Plastic & vinyl cleaner  
(P/N 413 711 200)  
6 x 1 L



A00B4V4

#### APPLICATION

Hood, bottom pan and seat.

Parts cleaner  
(P/N 413 711 809)  
320 g



A00B4X4

#### APPLICATION

Engine crankcase joining surfaces, pulleys and any greasy surfaces.

**NOTE:** This product replaces Loctite Safety solvent (P/N 413 708 200).

Gel instant adhesive  
(P/N 413 708 300)  
Loctite 454-40  
20 g (.70 oz)



A00B3O4

#### APPLICATION

Isolating foam and rubber strip.

Tough adhesive  
(P/N 413 408 300)  
Loctite Black Max  
3 mL (.10 oz)



A00B3P4

#### APPLICATION

Shifter boot or grip.

Stripped threads repair kit  
(P/N 413 708 600)  
Form-A-thread 81668

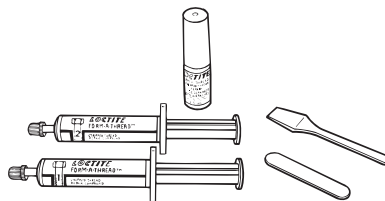

A00A1J4

#### APPLICATION

Repair damaged threads of grade 5 (SAE) or 8.8 (metric) maximum. Do not use in applications where temperatures will exceed 149°C (300°F) or on critical assemblies.

Paint for frame touch-up  
(P/N 413 401 000)  
Black semi-gloss  
(spray can)



A00B3H4

#### APPLICATION

All models with a black frame.

General purpose instant adhesive  
Loctite 495 (3 g)  
(P/N 293 800 021)

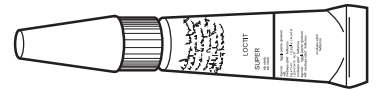

A00B2V4

#### APPLICATION

Rubber to metal bonding and most hard plastic.

**NOTE:** Only the P/N has been changed. This product is identical to the P/N 413 703 200.

## Section 01 SERVICE TOOLS AND SERVICE PRODUCTS

### Subsection 02 (SERVICE PRODUCTS)

## RECOMMENDED SERVICE PRODUCTS (continued)

High temperature RTV sealant  
Ultra Copper  
(P/N 413 710 300)  
(80 mL)



A00B5A4

#### APPLICATION

All models.

Clear silicone  
(P/N 293 800 033)



F01B1S4

#### APPLICATION

All models to seal bottom pan.

Shock oil  
(32 oz)  
(P/N 413 711 806)



A06F0P4

#### APPLICATION

T/A shocks.

Fuel stabilizer  
(12 x 8 oz)  
(P/N 413 408 600)



A00B3V4

#### APPLICATION

All models.

Bombardier Lube  
(12 x 14 oz)  
(P/N 293 600 016)



A00B4W4

#### APPLICATION

Steering ball joints on all models.

Bombardier cleaner  
(P/N 293 110 001) (400 g)  
(P/N 293 110 002) (4 L)



F01B2J4

#### APPLICATION

All models.

Molykote 111  
(P/N 413 707 000)



A00B3W4

#### APPLICATION

Crankshaft seals on all engines except ZX series ones.

**Section 01 SERVICE TOOLS AND SERVICE PRODUCTS**

Subsection 02 (SERVICE PRODUCTS)

**RECOMMENDED SERVICE PRODUCTS (continued)**

Super Lube (grease)  
(P/N 293 550 014)



A00B474

**APPLICATION**

Exhaust tail pipe grommet.