

ski-doo

OPERATOR'S GUIDE

2000

484 100 015

Mini Z

SAFETY WARNING

Disregarding any of the safety precautions and instructions contained in this *Operator's Guide*, *Safety Handbook* or on-product labels could cause injury, including the possibility of death.

This *Operator's Guide* handbook should remain with the snowmobile at all time.



BOMBARDIER
Recreational Products
After Sales Service
Valcourt (Quebec)
Canada J0E 2L0

The following are trademarks of Bombardier Inc.

BOMBARDIER®
MINI Z®

Litho'd in Canada (MMO2000-002A.fm GM)

®*Trademarks of Bombardier Inc.

©1999 Bombardier Inc. All rights reserved.

FOREWORD

Congratulations on your purchase of a new SKI-DOO snowmobile. Whatever model you have chosen, it is backed by the Bombardier warranty and a network of authorized Ski-Doo snowmobile dealers ready to provide the parts, service or accessories you may require.

Your dealer is committed to your satisfaction. He has taken training to perform the initial set-up and inspection of your snowmobile as well as completed the final adjustments before you took possession. At delivery, your dealer would have explained the snowmobile controls. We trust you have taken full advantage of this! If you need more complete servicing information, please ask your dealer about the *Ski-Doo MINI Z Shop Manual*.

At delivery, you were also informed of the warranty coverage and completed the Warranty Registration Form which is to be sent to us for processing. In the near future you should be receiving a warranty card which will confirm our receipt of the registration as well as be used for warranty or recall purposes.

The diagram shows a Ski-Doo Warranty Card with the following fields and labels:

- Dealer Number:** Points to the first 10-digit field (0000000000).
- Vehicle Model Number:** Points to the 5-digit field (00000).
- Vehicle Serial Number:** Points to the 10-digit field (0000/00/00).
- Owner:** Points to the personal information fields: FIRST NAME LAST NAME, STREET, CITY PROV./STATE POSTAL/ZIP CODE, and COUNTRY.
- Expiration Date (Year/Month/Day):** Points to the date field (0000/00/00).

The card features the **ski-doo** logo at the top and the slogan **Service par excellence / Excellence in Service** and **ENREGISTREMENT DE LA GARANTIE / WARRANTY REGISTRATION** at the bottom.

A00K04A

WARRANTY CARD

NOTICE TO PARENTS

Review this guide with any user of this snowmobile.

Please take time with the children to review the instructions on its safe and proper use, while paying attention to the on-product safety labeling before allowing them to ride snowmobile.

Understand the controls and operation of the snowmobile, carefully read the operator's guide, pay attention to the on-product safety labeling and review them with the children before allowing them to ride.

It is important that you supervise the children at all times in order to prevent serious injuries. It is at your discretion to allow unsupervised use only if you should pre-determine that all children have the ability strength and judgment to operate the snowmobile safely.

Do not allow children to ride snowmobile if they are younger than the recommended age of 6 years (or weighing over 100 lbs) or if they do not have the strength, skills or judgment required to operate the snowmobile. Always remember that your approach to safety influences the child. If available locally, enroll your children in a snowmobile safety training program.

THIS GUIDE SHOULD REMAIN WITH THE SNOWMOBILE AT ITS RESALE.

TABLE OF CONTENTS

SAFETY	6
SAFETY LABELING	7
BOMBARDIER LIMITED WARRANTY 2000 SKI-DOO® SNOWMOBILE	9
BOMBARDIER INTERNATIONAL LIMITED WARRANTY 2000 SKI-DOO® SNOWMOBILE	11
LIST OF CUSTOMER RELATIONS OFFICES	13
AUTHORIZED SKI-DOO DEALERS	13
<hr/>	
CHILD'S SECTION	14
SNOWMOBILE DESCRIPTION	15
CLOTHING	16
SNOWMOBILE CONTROLS	17
1) Throttle Lever.....	18
2) Brake Lever.....	18
3) Ignition Switch	18
4) Tether Cut-Out Switch	20
5) Emergency Cut-Out Switch	21
6) Rewind Starter Handle.....	21
7) Choke Button	22
8) Hood Latches	22
BEFORE YOU START	23
Throttle.....	23
Brake	24
Visual Inspection	25
Track	26
HOW TO START	27
HOW TO STOP	31
EMERGENCY STOP	32
FIRST RIDE	33

HOW TO RIDE	34
Sitting	34
Kneeling.....	35
Standing	36
Passenger.....	37
People at Front.....	37
SIGNALS	38
Stop	38
Left Turn.....	39
Right Turn.....	40
AFTER USE.....	40
<hr/>	
PARENT'S SECTION.....	41
HOW TO IDENTIFY YOUR SNOWMOBILE	42
Vehicle Serial Number Location	42
Engine Serial Number Location	43
ON-VEHICLE IMPORTANT INSTRUCTIONS.....	44
Chain Guard.....	44
Hood (above footrest).....	44
BREAK-IN PERIOD	45
Engine	45
10-Hour Inspection	45
BEFORE YOU START.....	46
PRE-START CHECK.....	47
Check Points	47
STARTING PROCEDURE	48
Manual Starting	48
FUEL AND OIL.....	49
Recommended Fuel	49
Recommended Oil	50
Engine Oil Level	51

REPAIR AND MAINTENANCE	53
Chain Guard Removal and Installation	54
Clutch Axle and Drive Chain Lubrication	54
Drive Chain Tension	55
Brake Condition.....	55
Brake Adjustment	56
Rear Suspension Condition.....	58
Suspension Stopper Straps Condition	58
Track Condition	58
Track Tension and Alignment.....	58
Steering and Front Suspension Mechanism	62
Wear and Condition of Skis and Runners	63
Exhaust System	63
Bulb Replacement.....	63
STORAGE.....	64
TROUBLESHOOTING.....	65
SPECIFICATIONS.....	67
LUBRICATION AND MAINTENANCE CHART	68
CHANGE OF ADDRESS OR OWNERSHIP	70

SAFETY

This guide uses the following symbols.

WARNING

Identifies an instruction which, if not followed, could cause serious personal injuries including possibility of death.

CAUTION: Denotes an instruction which, if not followed, could severely damage snowmobile components.

NOTE: Indicates supplementary information needed to fully complete an instruction.

WARNING

This snowmobile is classified as a children snowmobile. It is not designed to exceed speeds of 13 km/h (8 MPH), nor to carry passenger(s), cargo, pull a sleigh, toboggan or any object of similar nature.

Children should only be allowed to use the snowmobile in the presence or under the supervision of an adult.

Instruct children thoroughly as to the use of the snowmobile and ensure they are familiar with the snowmobile controls, area of use and riding practices before allowing them to operate the snowmobile.

Use of snowmobile should be limited to daylight operation only, in areas clear of obstacles and on adequate snow covered terrain. Ensure children do not operate the snowmobile on frozen bodies of water, or on snowmobile or ATV recreational trails or near streets, roadways, driveways or sidewalks.

Make sure area is free of wire fencing, tree stumps or other hazards.

Always make sure children wear all appropriate protective clothing including an approved safety helmet.

Always keep the snowmobile well serviced and maintained. Respect and comply with the manufacturer's recommended instructions as to the maintenance, service and storage of the snowmobile.

Do not modify or alter the snowmobile and/or any component. Ensure the hood is always closed and all guards are in place.

SAFETY LABELING

Safety standards for snowmobiles have been adopted by the Snowmobile Safety and Certification Committee of which Bombardier is a proud participating member. Assurance that your snowmobile meets these standards is easily checked by locating the Certification Label on a right vertical portion of the vehicle.

This label signifies that an independent testing laboratory has verified compliance with the SSCC safety standards. Other important labels on the vehicle are WARNING or CAUTION labels relating to maintenance and/or snowmobile operation. Ensure all such labeling is retained on the vehicle and its content is followed by vehicle operators.

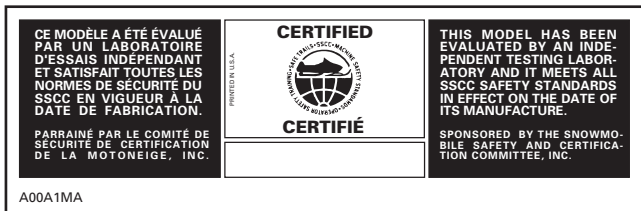

Observe the Following Warnings:

Do not allow children to refuel the snowmobile or attempt any repairs or servicing.

Securely attach the tether cord to the child's body prior to starting the engine.

Ensure that children do not operate snowmobile on snowmobile or ATV recreational trails or near streets, roadways, driveways or sidewalks. In most States and Provinces, it is considered an illegal operation.

Throttle mechanism should be checked for free movement before starting engine.

The snowmobile engine can be stopped by activating the emergency cut-out switch, pulling the tether cord or turning off the key.

Engine should be running only when chain guard is secured in place. Never run the engine without drive chain installed. Running an unloaded engine can prove to be dangerous.

Never run the engine when the track is raised off the ground or with the hood opened or removed.

Maintain the snowmobile in top mechanical condition at all times.

Do not lubricate throttle and/or brake cables and housings.

Only perform procedures as detailed in this guide. Unless otherwise specified, engine should be turned OFF and cold for all lubrication and maintenance procedures.

This snowmobile is designed for the driver only and no provisions have been made for a passenger.

The engine and components used in this particular model should not be used on any other type of equipment.

Most components of this snowmobile are built with parts dimensioned in the metric system. Most fasteners are metric and must not be replaced by customary fasteners or vice versa.

BOMBARDIER LIMITED WARRANTY 2000 SKI-DOO® SNOWMOBILE

1. WARRANTY COVERAGE PERIOD

In Canada, BOMBARDIER INC. ("Bombardier"), and in the USA, BOMBARDIER MOTOR CORPORATION OF AMERICA, warrants FROM THE DATE OF DELIVERY TO THE FIRST CONSUMER that each 2000 SKI-DOO snowmobile sold, as NEW and UNUSED and PREDELIVERED by an authorized North American SKI-DOO snowmobile dealer, will be free from any defects in material and/or workmanship for a period of:

TWELVE (12) CONSECUTIVE MONTHS, for private use owners. The warranty coverage period on a snowmobile delivered between June 1st and December 1st of a given year will expire December 1st of the following year; or

THREE (3) CONSECUTIVE MONTHS, for commercial use owners. The warranty coverage period on a snowmobile delivered between June 1st and December 1st of a given year will expire on March 1st of the following year.

All genuine Bombardier accessories, installed by an authorized SKI-DOO dealer at the time of delivery of the new and unused SKI-DOO, carry the same Warranty Coverage Period as for the SKI-DOO snowmobile.

2. WHAT BOMBARDIER WILL DO

BOMBARDIER will repair or replace, at its option, all genuine BOMBARDIER part found defective in material and/or workmanship, under normal use, maintenance and service, with a genuine BOMBARDIER part without charge for parts and labor, at any authorized SKI-DOO dealer during the Warranty Coverage Period.

3. CONDITION TO HAVE WARRANTY WORK VALIDATED

The customer must notify an authorized SKI-DOO dealer within two (2) days of the appearance of a defect in material and/or workmanship and present to the servicing authorized SKI-DOO dealer the SKI-DOO Warranty Registration Card or a proof of purchase of the NEW and UNUSED 2000 SKI-DOO snowmobile and must sign the repair/work order prior to the start of the repair in order to validate a warranty repair. All parts replaced under this limited warranty become the property of BOMBARDIER.

4. EXCLUSIONS — ARE NOT WARRANTED

- Normal wear and tear items;
- Labor, parts and lubricant costs of all maintenance services;
- Damage caused by failure to provide proper maintenance and/or storage, as described in the "2000 SKI-DOO snowmobile Operator's Guide";
- Damage resulting from improper repairs, modifications or use of non-approved parts or, repairs done by a non-authorized SKI-DOO dealer;
- Damage resulting from abuse, misuse, neglect, racing or using the SKI-DOO snowmobile on surfaces other than snow;
- Damage resulting from accident, fire, theft, vandalism or any act of God;
- Incidental or consequential damages, or damages of any kind as but not limited to towing charges, telephone calls or taxi; and
- Damages resulting from improper service or maintenance.

5. LIMITATIONS OF LIABILITY

This warranty gives you specific rights, and you may also have other legal rights which may vary from state to state, or province to province. **WHERE APPLICABLE, THIS WARRANTY IS EXPRESSLY GIVEN AND ACCEPTED IN LIEU OF ANY AND ALL OTHER WARRANTIES, EXPRESSED OR IMPLIED, INCLUDING WITHOUT LIMITATION ANY WARRANTY OF MERCHANTABILITY OR FITNESS FOR ANY PARTICULAR PURPOSE.**

Neither the distributor, any authorized SKI-DOO dealer nor any other person has been authorized to make any affirmation, representation or warranty other than those contained in this warranty, and if made, such affirmation, representation or warranty shall not be enforceable against BOMBARDIER or any other person.

In no event shall BOMBARDIER be liable for special, consequential or incidental damages, including but not limited to loss of use and transportation costs. Some states or provinces do not allow the exclusion or limitation of incidental or consequential damages, or limitations on how long an implied warranty lasts, so the above limitation or exclusion may not apply.

BOMBARDIER reserves the right to modify this warranty at any time, being understood that such modification will not alter the warranty conditions applicable to the SKI-DOO snowmobile sold while this warranty is in effect.

6. CONSUMER ASSISTANCE

- a. In the event of a controversy or a dispute arising in connection with this BOMBARDIER LIMITED WARRANTY, BOMBARDIER suggests that you try to resolve the issue at the dealership level. We recommend discussing the issue with the authorized dealer's service manager or owner.
- b. If further assistance is required, the DISTRIBUTOR's Service Department should be contacted in order to resolve the matter.
- c. If the issue has still not been resolved, please submit in writing your complaint to:

In Canada:

BOMBARDIER
RECREATIONAL PRODUCTS
SNOWMOBILES
CUSTOMER ASSISTANCE CENTER
VALCOURT QC JOE 2LO
Tel: (450) 532-5000

In USA:

BOMBARDIER MOTOR
CORPORATION OF AMERICA
RECREATIONAL PRODUCTS
SNOWMOBILES
CUSTOMER ASSISTANCE CENTER
P.O. BOX 8035
7575 BOMBARDIER COURT
WAUSAU WI 54402-8035
Tel: (715) 848-4957

BOMBARDIER RECREATIONAL PRODUCTS
SNOWMOBILES
January 1999

® Registered trademark of Bombardier Inc. and/or affiliates.

BOMBARDIER INTERNATIONAL LIMITED WARRANTY 2000 SKI-DOO® SNOWMOBILE

1. WARRANTY COVERAGE PERIOD

BOMBARDIER INC. ("Bombardier"), as manufacturer, warrants FROM THE DATE OF DELIVERY TO THE FIRST CONSUMER that each 2000 SKI-DOO snowmobile sold anywhere in the world except the United States and Canada, as NEW and UNUSED and PREDELIVERED by an authorized North American SKI-DOO snowmobile dealer, will be free from any defects in material and/or workmanship for a period of:

TWELVE (12) CONSECUTIVE MONTHS, for private use owners. The warranty coverage period on a snowmobile delivered between June 1st and December 1st of a given year will expire December 1st of the following year; or

THREE (3) CONSECUTIVE MONTHS, for commercial use owners. The warranty coverage period on a snowmobile delivered between June 1st and December 1st of a given year will expire on March 1st of the following year.

2. WHAT BOMBARDIER WILL DO

BOMBARDIER through the local SKI-DOO International Distributor will, during the Warranty Coverage Period, repair or replace, at its option, all genuine BOMBARDIER part found defective in material and/or workmanship, under normal use, maintenance and service, with a genuine BOMBARDIER part without charge for parts and labor, at any local authorized SKI-DOO dealer.

3. CONDITION TO HAVE WARRANTY WORK VALIDATED

The customer must notify a local authorized SKI-DOO dealer within two (2) days of the appearance of a defect in material and/or workmanship and present to the servicing authorized SKI-DOO dealer the SKI-DOO Warranty Registration Card or a proof of purchase of the NEW and UNUSED 2000 SKI-DOO snowmobile and must sign the repair/work order prior to the start of the repair in order to validate a warranty repair. All parts replaced under this limited warranty become the property of BOMBARDIER.

4. EXCLUSIONS — ARE NOT WARRANTED

- Normal wear and tear items;
- Labor, parts and lubricant costs of all maintenance services;
- Damage caused by failure to provide proper maintenance and/or storage, as described in the "2000 SKI-DOO snowmobile Operator's Guide";
- Damage resulting from improper repairs, modifications or use of non-approved parts or, repairs done by a non-authorized SKI-DOO dealer;
- Damage resulting from abuse, misuse, neglect, racing or using the SKI-DOO snowmobile on surfaces other than snow;
- Damage resulting from accident, fire, theft, vandalism or any act of God;
- Incidental or consequential damages, or damages of any kind as but not limited to towing charges, telephone calls or taxi; and
- Damages resulting from improper service or maintenance.

5. LIMITATIONS OF LIABILITY

This warranty gives you specific rights, and you may also have other legal rights resulting from the application of mandatory national laws which may vary from country to country. **WHERE APPLICABLE, THIS WARRANTY IS EXPRESSLY GIVEN AND ACCEPTED IN LIEU OF ANY AND ALL OTHER WARRANTIES, EXPRESSED OR IMPLIED, INCLUDING WITHOUT LIMITATION ANY WARRANTY OF MERCHANTABILITY OR FITNESS FOR ANY PARTICULAR PURPOSE.**

In no event shall BOMBARDIER be liable for special, consequential or incidental damages, including but not limited to loss of use and transportation costs. Some country do not allow the exclusion or limitation of incidental or consequential damages, or limitations on how long an implied warranty lasts, so the above limitation or exclusion may not apply.

Neither the SKI-DOO International Distributor, the selling local SKI-DOO dealer nor any other person has been authorized to make any affirmation, representation or warranty other than those contained in this warranty, and if made, such affirmation, representation or warranty shall not be enforceable against BOMBARDIER or any other person.

Every SKI-DOO snowmobile is sold with the English version of this warranty. A specific SKI-DOO International Distributor may elect to translate this warranty into local language, it is then understood and agreed that in the event of any discrepancy among the two versions, the English version shall prevail.

It is the customer's responsibility to ensure that the SKI-DOO snowmobile complies with all snowmobile regulations and standards of any country, other than the original country of sale, where the SKI-DOO snowmobile is intended to be used. BOMBARDIER reserves the right to modify this warranty at any time, being understood that such modification will not alter the warranty conditions applicable to the SKI-DOO snowmobile sold while this warranty is in effect.

6. CONSUMER ASSISTANCE

- a. In the event of a controversy or a dispute arising in connection with this BOMBARDIER INTERNATIONAL LIMITED WARRANTY, BOMBARDIER suggests that you try to resolve the issue at the dealership level. We recommend discussing the issue with the authorized dealer's service manager or owner.
- b. If further assistance is required, the authorized local SKI-DOO INTERNATIONAL DISTRIBUTOR's Service Department should be contacted in order to resolve the matter.
- c. If the issue has still not been resolved, please submit in writing your complaint to:

BOMBARDIER
RECREATIONAL PRODUCTS
SNOWMOBILES
INTERNATIONAL SERVICE DEPARTMENT
VALCOURT QUEBEC JOE 2LO
CANADA

BOMBARDIER
RECREATIONAL PRODUCTS
SNOWMOBILES

January 1999

® Registered trademark of Bombardier Inc. and/or affiliates.

LIST OF CUSTOMER RELATIONS OFFICES



CANADA

BOMBARDIER INC.

726 St-Joseph Street
Valcourt, Quebec, Canada
J0E 2L0
Telephone: (450) 532-5000
Fax: (450) 532-5077



USA

BOMBARDIER MOTOR CORPORATION OF AMERICA

7575 Bombardier Court
P.O. Box 8035, Wausau, WI
54402-8035. USA
Telephone: (715) 848-4957
Fax: (715) 848-4978

OTHER COUNTRIES

For customer relations, contact your local distributor.
Your local dealer can provide distributor contact information.

AUTHORIZED SKI-DOO DEALERS

For Canada and USA

To find the nearest authorized SKI-DOO dealer, dial: 1-800-375-4366.

CHILD'S SECTION

SNOWMOBILE DESCRIPTION

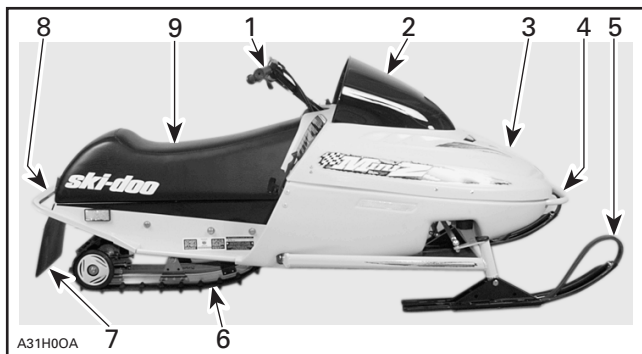

1. Handlebar
2. Windshield
3. Hood
4. Front bumper
5. Skis
6. Track
7. Snow guard
8. Rear bumper
9. Seat

CLOTHING

Always wear all appropriate protective clothing including an approved safety helmet.

User(s) should be adequately clothed. Do not permit loose clothing which could be entangled in moving parts or get snagged on tree branches.

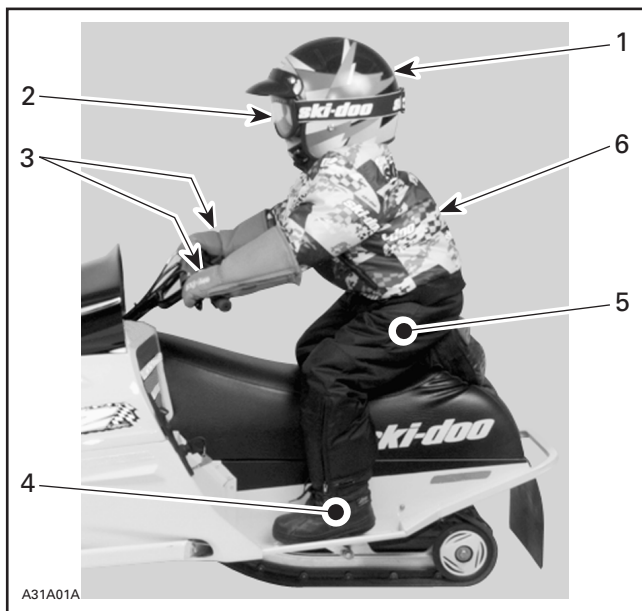

1. Safety helmet
2. Goggles
3. Mittens
4. Warm-up boots
5. Warm-up pants
6. Jacket

SNOWMOBILE CONTROLS

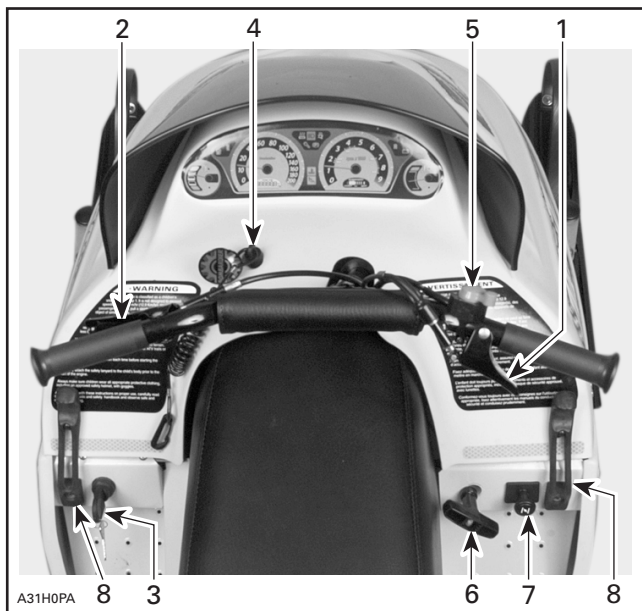

1. Throttle lever
2. Brake lever
3. Ignition switch
4. Tether cut-out switch
5. Emergency cut-out switch
6. Rewind starter handle
7. Choke button
8. Hood latches

1) Throttle Lever

Squeezing the lever with your thumb will make the snowmobile go faster. Releasing the lever slows the snowmobile.

WARNING

Test the throttle lever operation each time you want to start the engine. This must be done before starting. The lever must return to its original position once released.

2) Brake Lever

Squeezing the brake lever toward the handlebar slows and stops the snowmobile. The throttle lever should also be released to bring the snowmobile to a complete halt.

CAUTION: Do not apply throttle and brake at the same time.

3) Ignition Switch

The lights come ON automatically whenever the engine is running.

Manual Starting

Key operated, 2-position switch. To start the engine, first turn the key to ON position. To stop the engine, turn the key to OFF position.

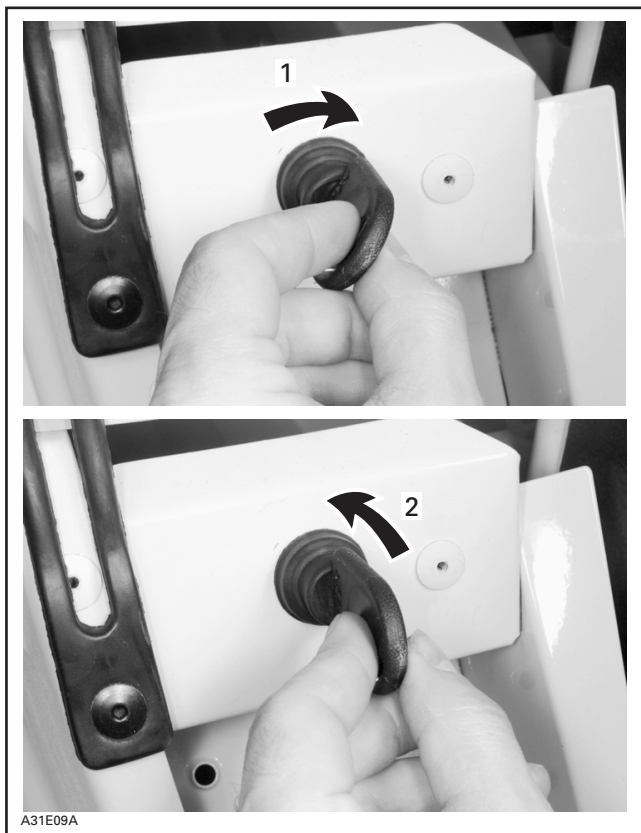

1. ON
2. OFF

4) Tether Cut-Out Switch

When the tether cord is pulled off its switch, the engine stops and prevents the snowmobile from running away if a throttle problem occurs or you fall off while riding. Always clip the tether cord to your clothing and the tether cut-out switch before starting the engine. Leave it attached during your ride.

WARNING

Do not remove disk from tether cord. This safety device will unplug tether cord cap if hood is lifted. Engine will automatically stop.

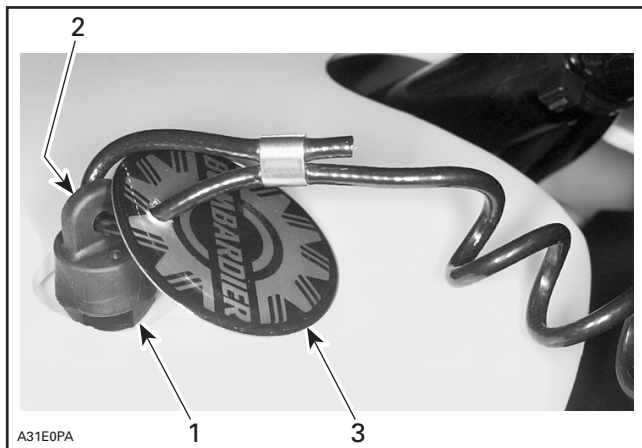

1. Tether cut-out switch
2. Tether cord cap
3. Do not remove this disk

5) Emergency Cut-Out Switch

A 3-position type switch located on the right side of the handlebar. To stop the engine in an emergency, push the button to the front or rear OFF position and simultaneously apply the brake. To restart, button must be at middle ON position.

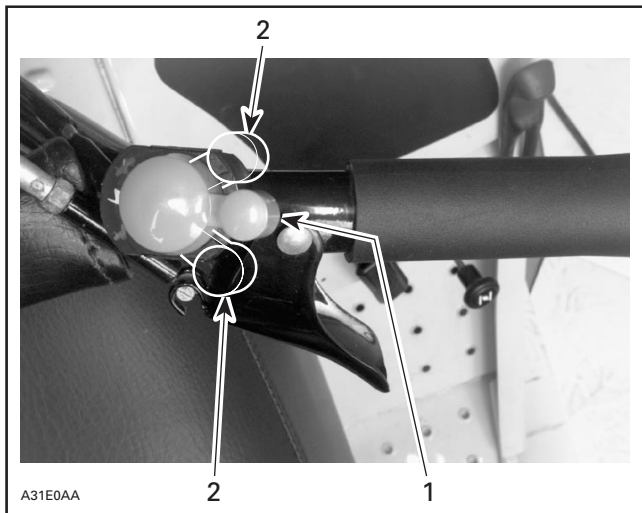

1. ON
2. OFF

6) Rewind Starter Handle

Auto-rewind type located on right hand side of snowmobile. To engage mechanism, pull handle slowly until a resistance is felt then pull vigorously. Slowly release handle.

7) Choke Button

This device features a multi-position button to facilitate cold start.

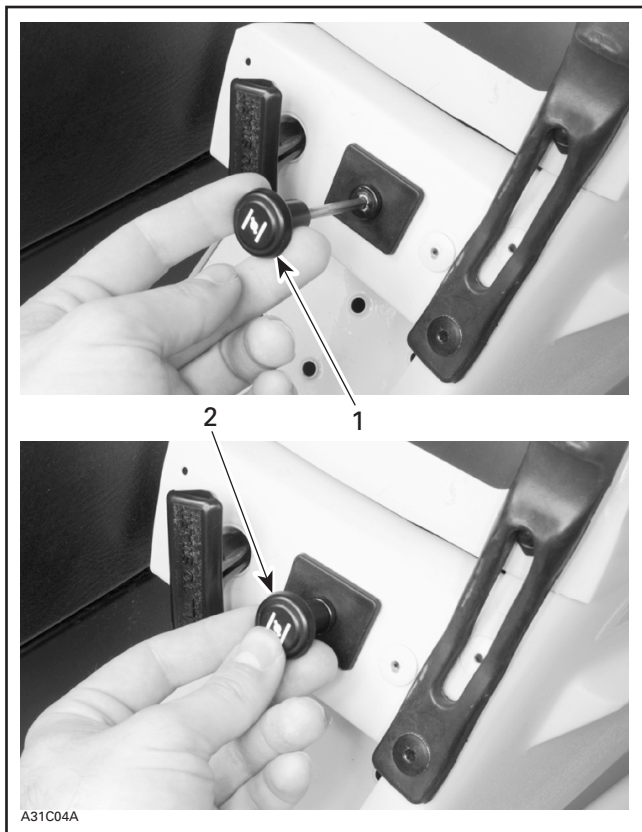

1. Cold start
2. Warm start

8) Hood Latches

Hood latches are used to lock hood to its anchors.

BEFORE YOU START

Always do a pre-start inspection **WITH YOUR PARENTS OR ADULT BEFORE** you turn on the ignition.

Throttle

Operate the throttle 2 or 3 times before you turn on the ignition. Does it return freely to the idle or closed position, as shown?



CORRECT THROTTLE POSITION BEFORE STARTING

Brake

Test your brake lever as you did the throttle.



CORRECT BRAKE LEVER POSITION BEFORE STARTING

Visual Inspection

Make certain hood is fastened with hood latches and remove any snow and ice buildup from lights, windshield and running boards.



LEFT SIDE SHOWN — HOOD LATCH IN FASTENING POSITION

Track

Make sure the track is not frozen to the ground. To verify, lift rear of snowmobile or ask an adult to help.



LIFTING REAR OF SNOWMOBILE

WARNING

Never lift snowmobile if engine is running.

HOW TO START

Never attempt to start the engine unless the throttle returns to its normal or idle position. Verify this **before** starting. Keep hands off of throttle when actually starting.

Put on your safety helmet and attach tether cord to your clothing.



A31A05A

TETHER CORD ATTACHED TO CLOTHING

Connect tether cord cap to snowmobile switch.



TETHER CORD CAP CONNECTED TO SWITCH

Turn the ignition key to the ON position.



IGNITION KEY TO THE ON POSITION

Set emergency cut-out switch to middle position, as shown in the next photo.



A31E02A

EMERGENCY CUT-OUT SWITCH TO MIDDLE POSITION

Engage choke only if the engine is cold.



A31C0EA

CHOKE IS ENGAGED FOR COLD ENGINE STARTING

Pull starter handle to start engine.

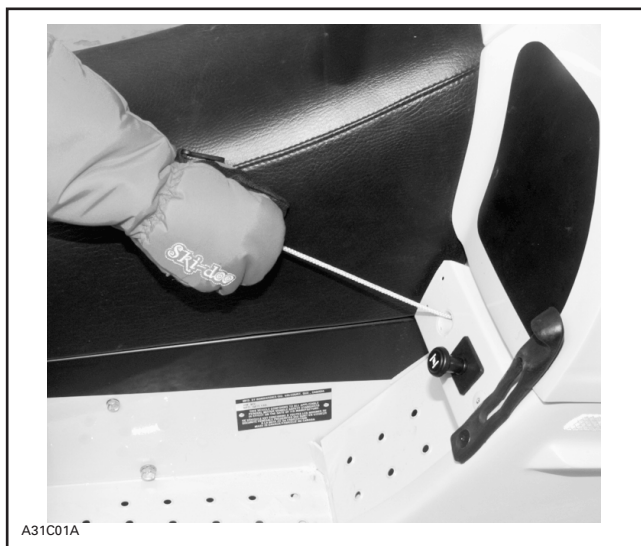

STARTER HANDLE IS PULLED

Allow engine to warm then disengage choke before operating at full throttle.

While the engine is warming, check the headlight and the taillight, then set the emergency cut-out switch to both extreme positions to be certain it will stop the engine. Before restarting your snowmobile, recheck the throttle control and be sure the vehicle is headed away from people or objects. Now re-start your engine again.

HOW TO STOP

Before riding your snowmobile, you should understand how to stop it.

Release the throttle and gradually depress the brake lever on the left side of the handlebar and then turn the ignition key to the OFF position.



TURNING IGNITION KEY TO STOP ENGINE

EMERGENCY STOP

In an emergency, you may stop your vehicle by pressing the emergency stop switch located near the throttle control and applying the brake.

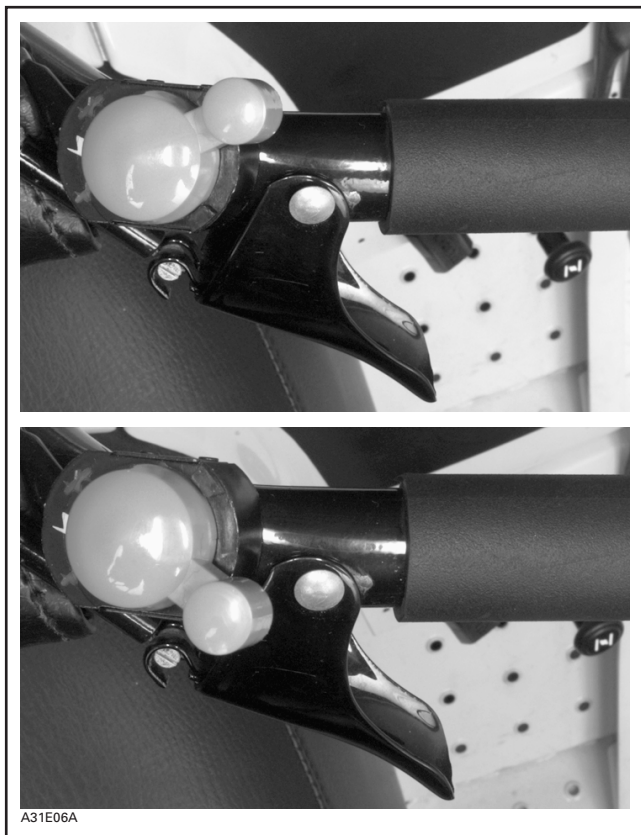

BOTH OFF POSITIONS FOR EMERGENCY STOP

Remember, a snowmobile cannot “stop on a dime”. Braking characteristics vary with deep snow, packed snow or ice. If the track is locked during hard braking, skidding may result.

FIRST RIDE

Under adult supervision, select an open snow covered area which is free of hazards.

Push on throttle lever while holding on to handlebar.



TO ACCELERATE

Practice riding by using throttle lever to accelerate then brake lever to brake.

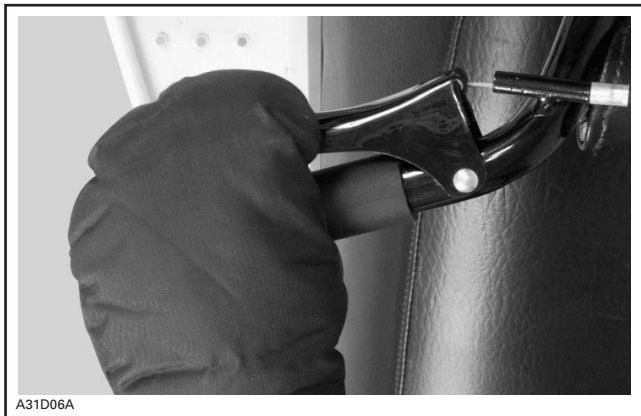

TO BRAKE

Go slowly and avoid all obstacles.

HOW TO RIDE

Your riding position and balance are the 2 basic principles of making your snowmobile go where you want it to.

These are 3 ways to position your body while riding the snowmobile; sitting, kneeling or standing.

Sitting



FEET ON THE RUNNING BOARDS, KNEES AND HIPS FLEXIBLE



WORN

Kneeling



ONE FOOT ON THE RUNNING BOARD AND THE OPPOSITE KNEE ON THE SEAT

Standing



BOTH FEET ON THE RUNNING BOARD WITH KNEES FLEXED

WARNING

Be watchful of any overhead branches or other hazards.

Passenger

This vehicle is intended for one operator only, no passenger.



WORN

People at Front

Make certain your snowmobile is pointed away from people or objects before you start it. No one is to be standing in front of or in back of the snowmobile.



BAD

SIGNALS

WARNING

Always be careful of other snowmobiles ahead or near you.
Stop or steer away from others.

If you intend to stop, raise either hand straight above your head. A left turn is indicated by extending your left hand straight out in the proper direction. For right turns, extend the left arm and raise the hand to a vertical position so it forms a right angle at the elbow.

Stop



A31H05A

TO INDICATE STOP

Left Turn



A31H06A

TO INDICATE LEFT TURN

Right Turn



A31H07A

TO INDICATE RIGHT TURN

AFTER USE

When you return from your ride, stop the engine and remove the tether cord. Talk to your parents or the owner of the snowmobile about your ride.

Remember, always drive carefully with your snowmobiling.

PARENT'S SECTION

HOW TO IDENTIFY YOUR SNOWMOBILE

The main components of the snowmobile (engine and frame) are identified by different serial numbers. It may sometimes become necessary to locate these numbers for warranty purposes or to trace your snowmobile in the event of loss. These numbers are required by the dealer to complete warranty claims properly. No warranty will be allowed by Bombardier Inc. if the engine serial number or VIN is removed or mutilated in any way. We strongly recommend that you take note of all the serial numbers on your snowmobile and supply them to your insurance company.

Vehicle Serial Number Location



1. *Serial number*

Engine Serial Number Location

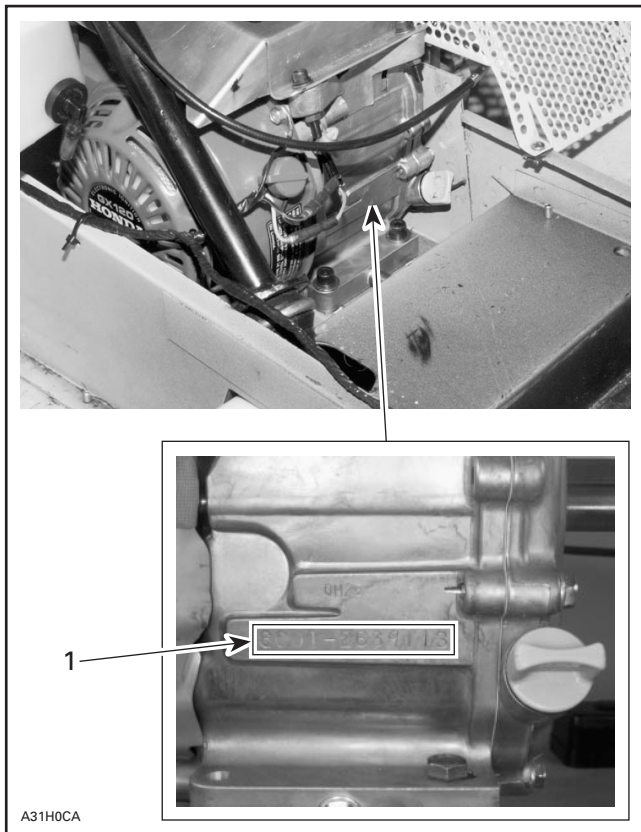

1. Engine serial number

ON-VEHICLE IMPORTANT INSTRUCTIONS

Please read the following instructions carefully before operating snowmobile.

Chain Guard

WARNING!

**Do not run engine without
this guard in place.**

AVERTISSEMENT!

**Ne pas mettre le moteur
en marche sans ce protecteur.**

A31A0DA

Hood (above footrest)

◆ WARNING

This snowmobile is classified as a children's snowmobile, group 1. It is not designed to exceed speeds of eight (8) m/hr (12.9 Km/hr), nor to carry passenger(s), cargo, pull a sleigh, toboggan or any object of similar nature.

Children should only be allowed to use the snowmobile in the presence or under the supervision of an adult. It is recommended that children using this snowmobile be not less than six (6) years of age.

Use of snowmobile should be limited to daylight operation, in areas clear of obstacles, on adequate snow covered terrain, and not on frozen bodies of water, snowmobile or ATV trails or near streets or roadways.

Test the throttle lever operation each time before starting the engine.

Securely attach the safety lanyard to the child's body prior to the start of the engine.

Always make sure children wear all appropriate protective clothing, including an approved safety helmet, with goggles.

Always comply with these instructions on proper use, carefully read the operator's guide and safety handbook and observe safe and responsible riding.

A31A0CA

BREAK-IN PERIOD

Engine

A break-in period of 10 operating hours is required before running the snowmobile at full throttle.

CAUTION: Never mix fuel and oil. This snowmobile is equipped with a 4-cycle engine.

During this period, maximum throttle should not exceed 3/4. **However, brief full acceleration and speed variations contribute to a good break-in.** Continued wide open throttle accelerations, prolonged cruising speeds and engine overheating are detrimental during the break-in period.

Always remove and clean spark plug after engine break-in.

10-Hour Inspection

As with any precision piece of mechanical equipment, we suggest that after the first 10 hours of operation or 30 days after the purchase, whichever comes first, your snowmobile be checked by an authorized dealer. This inspection will give you the opportunity to discuss the unanswered questions you may have encountered during the first hours of operation.

The 10-hour inspection is at the expense of the snowmobile owner.

BEFORE YOU START

Always do a pre-start inspection BEFORE you turn on the ignition.

Throttle — Operate the throttle 2 or 3 times before you turn on the ignition. Does it return freely to the idle or closed position?

Brake controls — Test your brake control as you did the throttle.

Visual inspection — Inspect the entire vehicle for loose or worn parts. Make certain hood is fastened. Remove any snow and ice buildup from lights, windshield and running boards. Make sure the track is not frozen to the ground.

Fuel/oil — Do you have enough?

Steering — Be certain the handlebar works freely and turns both ways. There should be no excessive play in the steering linkage or connections to the skis. Remove accumulated ice and snow from underneath the hood.

Drive chain — Check for excessive wear.

Track — Be sure it turns freely and is free of ice, snow or other foreign objects. The track should be “cleared” with the engine shut off. Personal injury will result if contact is made with a rotating track, or if someone is hit by snow, ice or other debris being thrown by the track.

Check weather forecast: Will you be warm enough?

Make certain your snowmobile is pointed away from people or objects before you start it. No one is to be standing in front of or in back of the snowmobile.

PRE-START CHECK

Check Points

- Activate the throttle several times to check that it operates easily and smoothly. It must return to idle position when released.
- Activate the brake lever and make sure the brake fully applies before the brake lever touches the handlebar grip. It must fully return when released. See section **Brake Adjustment** on page 56 in this guide.
- Verify skis and steering operate freely.
- Verify track and idler wheels are unfrozen and free to turn.
- Check fuel and engine oil level (**to be done by an adult only**).
- Ensure fuel shut-off valve is in fully open position. Fuel shut-off valve is located on carburetor in engine compartment.
- Clean and check operation of the headlight and taillight.



WARNING

Only start the snowmobile once all components are checked and functioning properly.

STARTING PROCEDURE

- Re-check throttle operation.
- Ensure that the emergency cut-out switch is in the ON position.
- Ensure the tether cut-out cap is in position and that the cord is attached to child clothing.
- Check that tether cord disk is in place and in good condition. This disk will unplug tether cord and stop engine if children try to open hood while engine is running. See page 20.
- Set choke button to ON or OFF position, depending of the weather. See page 22.

Manual Starting

Insert the key in the ignition switch and turn to ON position.

Grasp manual starter handle firmly and crank engine.



Do not apply throttle while starting.

FUEL AND OIL

Recommended Fuel

Use regular unleaded gasoline, available from most service stations or gasohol containing less than 10% of ethanol or methanol. The gasoline used must have an octane number $(R + M)/2$ of 86 or higher.

NOTE: In most service stations pump octane number corresponds to $(R + M)/2$ octane number.

CAUTION: Never mix oil with fuel. This snowmobile has a 4-cycle engine. Oil must be added to engine base only.

CAUTION: Never experiment with other fuels. The use of unrecommended fuel can result in snowmobile performance deterioration and damage to critical parts in the fuel system and engine components.

WARNING

Never top up the fuel tank before placing the snowmobile in a warm area. As temperature increases, fuel expands and might overflow. Fuel is flammable and explosive under certain conditions. Always wipe off any fuel or oil spillage from the snowmobile.

WARNING

Do not allow children to refuel the snowmobile.



A31A02A

WRONG

Recommended Oil

Always maintain oil engine level with 4-stroke engine oil that meets or exceeds the requirements for API service classification SF or SG. Always check the API service label on the oil container to be sure it includes the letters SF or SG.

SAE 5W/30 is recommended for general, all temperature use.

Other viscosities shown in the chart may be used when the average temperature in your area is within the indicated range.

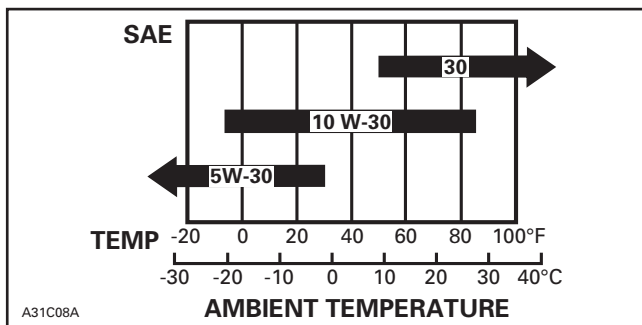

A31C08A

Engine Oil Level

NOTE: This should only be done by an adult.

With snowmobile on a level surface, check the oil level by removing dipstick at engine base. Oil level must be to the top of the oil filler neck. If not, refill up to oil filler neck using SAE 5W/30 recommended for general use.

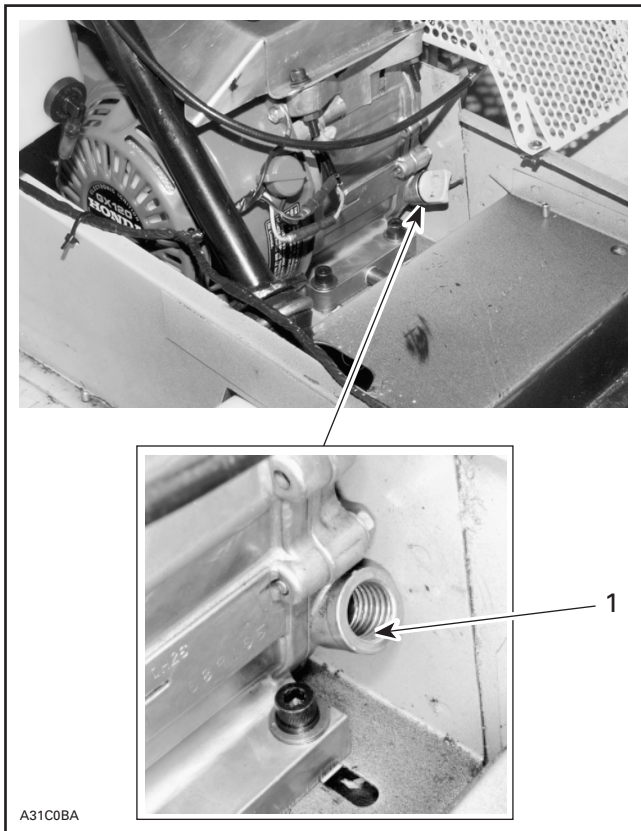

CHECKING OIL LEVEL

1. Top of the oil filler neck

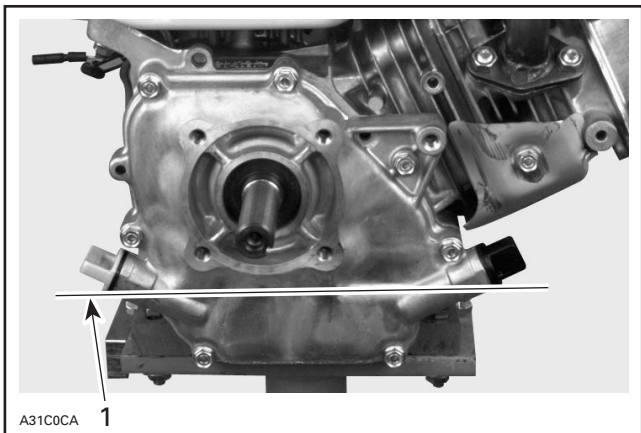

1. *Proper oil level*

⚠ WARNING

Check level and refill every time you refuel. Do not overfill.
Wipe off any spillage.

REPAIR AND MAINTENANCE

NOTE: All maintenance should be done by an adult or an authorized SKI-DOO dealer and according to these directions as well as the LUBRICATION AND MAINTENANCE CHART.

Do not allow children to lift hood to attempt repairs or maintenance.



WRONG

WARNING

Engine and its components may be hot.

Chain Guard Removal and Installation

Open hood. Remove chain guard retaining screws and lift off the guard.

WARNING

When removing chain guard, ensure that engine is not running.

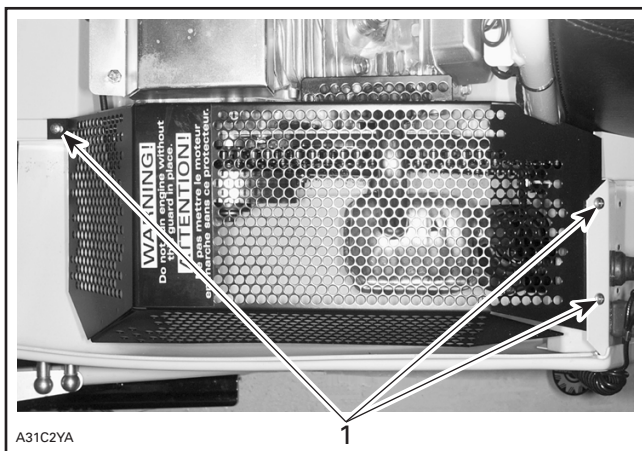

CHAIN GUARD

1. Retaining screws

Clutch Axle and Drive Chain Lubrication

Clutch Axle Lubrication

Remove chain guard.

Remove chain from clutch gear.

NOTE: Do not remove chain from driven gear. Chain may be difficult to reinstall.

Remove clutch nut and slide out the clutch.

Put clutch on a bench and drip a few drops of oil into clutch sleeve, as shown in the next illustration.

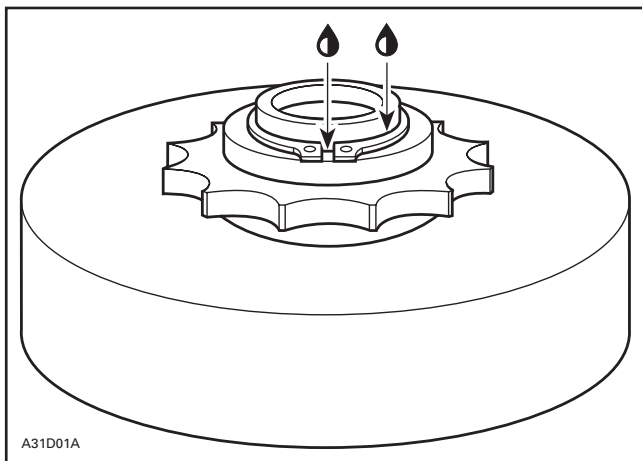

CLUTCH LUBRICATION

Reinstall clutch. Torque retaining screw to 23 N•m (17 lbf•ft).

Drive Chain Lubrication

With chain properly installed on both gears, spray aerosol chain oil over the chain.

CAUTION: Always lubricate drive chain slightly. Oil must not contact brake pads.

Drive Chain Tension

Snowmobile is equipped with an automatic tensioner. Ensure that tensioner spring is not damaged.

Brake Condition

The brake mechanism on the snowmobile is an essential safety device. Keep this mechanism in proper working condition. Above all, do not operate the snowmobile without an effective brake system. Periodically verify the condition/wear of the brake pads.

Brake Adjustment

Fully apply brake with brake lever. If brake lever is not within 15 mm (19/32 in) to 20 mm (25/32 in) of the handlebar, readjust brake. Refer to the following photo.

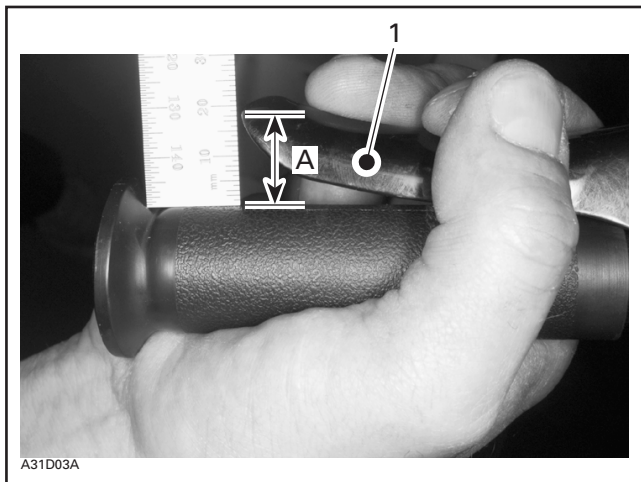

1. Brake lever

A. If measurement is not within 15 mm (19/32 in) to 20 mm (25/32 in), readjust brake

To adjust brake, loosen Allen screw then pull on brake cable. Refer to the next photo.

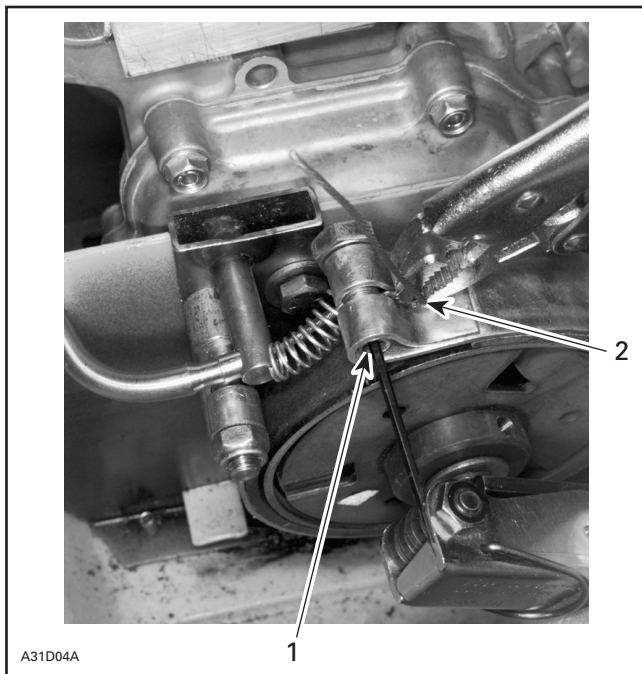

1. Loosen Allen screw
2. Pull brake cable with pliers

Retighten Allen screw.

WARNING

Always reinstall chain guard. Do not operate engine with hood opened or chain guard removed. Improper servicing, modification or poor adjustment may affect gears performance and life. Always obtain dealer advice before servicing or modifying the drive or driven gears. Always respect maintenance schedules.

Rear Suspension Condition

Visually inspect all suspension components including slider shoes, springs, wheels, etc.

NOTE: During normal driving, snow will act as a lubricant and coolant for the slider shoes. Extensive riding on ice or sanded snow, will create excessive heat build-up and cause premature wear of slider shoes.

Suspension Stopper Straps Condition

Inspect stopper straps for wear and cracks, bolts and nuts for tightness. If loose inspect holes for deformation. Replace as required. Torque nut to 9 N•m (80 lbf•in).

Track Condition

Lift the rear of the snowmobile and support it off the ground. With the engine off, rotate the track by hand, and inspect condition. If worn or cut, or if track fibers are exposed, or if missing or defective inserts or guides are noted; contact an authorized dealer.



WARNING

Do not operate or rotate a track if torn, damaged or excessively worn.

Track Tension and Alignment

Tension

NOTE: The snowmobile should be ridden in snow about 15 to 20 minutes prior to adjusting track tension.

Lift rear of snowmobile and support it with a **snowmobile mechanical stand**.

Allow the suspension to extend normally and check gap 60 mm (2-3/8 in) from rear idler wheel bracket. The gap should be as given in the specification section of this guide. If the track tension is too loose, track will have a tendency to thump.

NOTE: A belt tension tester (P/N 414 348 200) may be used to measure deflection as well as force applied.

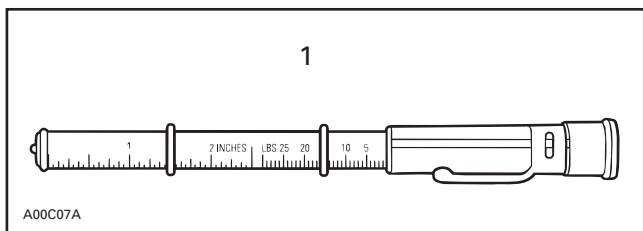

1. Belt tension tester

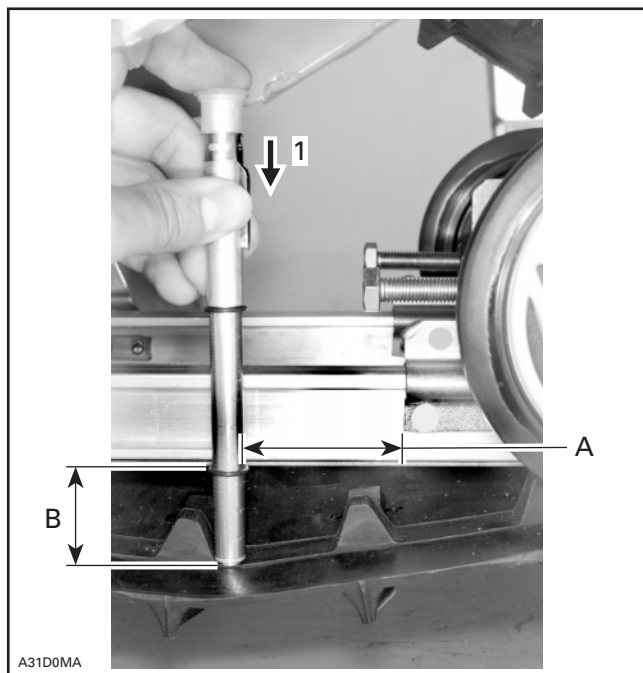

- 1. 7.3 kg (16 lb)
- A. 60 mm (2-3/8 in)
- B. 35 mm (1-3/8 in)

CAUTION: Too much tension will result in power loss and excessive stresses on suspension components.

To adjust tension:

- Loosen the rear idler wheel retaining screws.
- Loosen the lock nuts then turn adjustment screws to adjust.

If correct tension is unattainable, contact an authorized dealer.

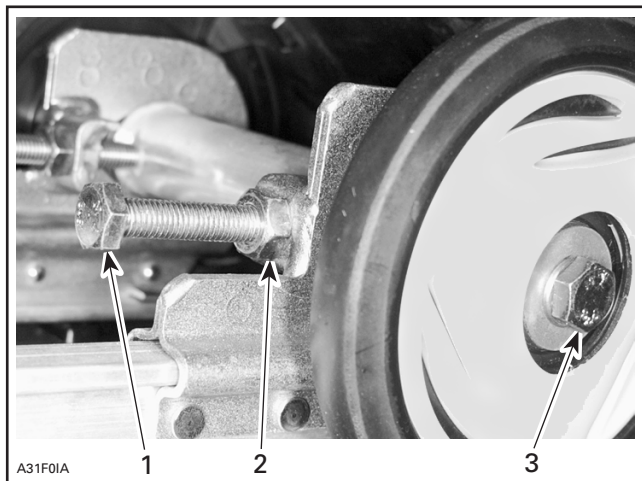

1. Adjustment screw
2. Loosen lock nut
3. Loosen screw

Alignment

NOTE: Track tension and alignment are interrelated. Do not adjust one without the other.

WARNING

Before checking track alignment, ensure that the track is free of all particles which could be thrown out while track is rotating. Keep hands, tools, feet and clothing clear of track. Ensure no one is standing in close proximity to the snowmobile.

Start the engine and accelerate slightly so that track barely rotates. This must be done in a short period of time (15 to 20 seconds). Check that the track is well centered; equal distance on both sides between edges of track guides and slider shoes.

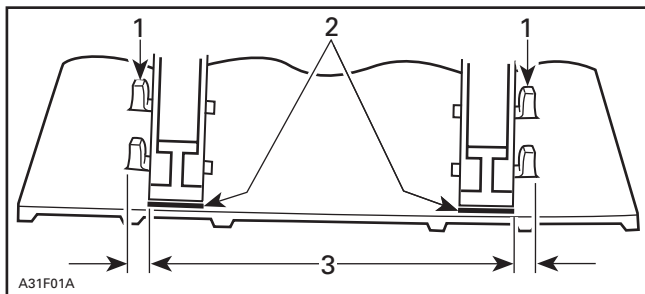

TYPICAL

1. Guides
2. Slider shoes
3. Equal distance

To correct, **stop the engine**: Loosen the lock nuts and tighten the adjustment screw on side where the slider shoe is the farthest from the track guides.

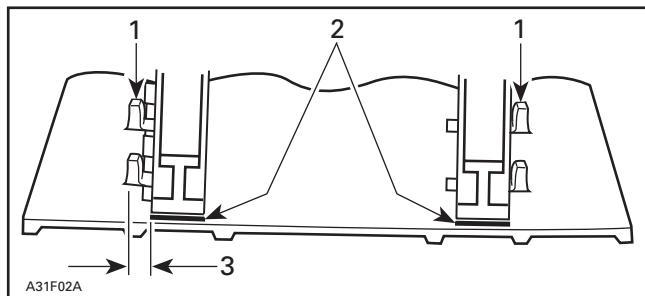

TYPICAL

1. Guides
2. Slider shoes
3. Tighten on this side

Tighten lock nuts and rear idler wheel retaining screws.

WARNING

If lock nuts or retaining screws are not tightened properly, the adjusting screws could loosen causing the track to become extremely loose and, under some operating conditions, allow the idler wheels to climb over the track lugs forcing the track against the tunnel causing the track to “lock”.

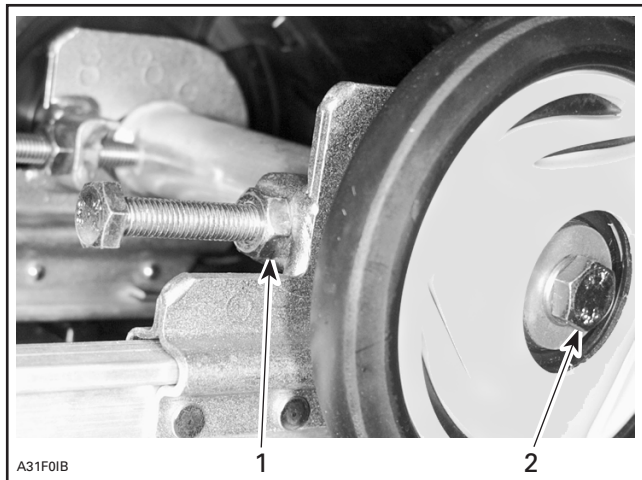

1. *Retighten lock nuts*
2. *Retighten rear idler wheel retaining screws*

Restart engine and rotate track slowly to recheck alignment.

Reposition snowmobile on ground.

Steering and Front Suspension Mechanism

Visually inspect steering and front suspension mechanism for tightness of components (steering arms, control arms and links, tie rods, ball joints, ski coupler bolts, etc.). If necessary, contact your dealer.

Wear and Condition of Skis and Runners

Check the condition of the skis and ski runners. If worn, contact your authorized dealer.

WARNING

Excessively worn skis and/or ski runners will affect snowmobile control.

Exhaust System

The tail pipe of the muffler should be centered with the exit hole in the bottom pan. It must be free of rust or leaks.

The exhaust system is designed to reduce noise and to improve the total performance of the engine. If any exhaust system component is removed from the engine, severe engine damage will result.

Bulb Replacement

Always check light operation after bulb replacement.

Headlight

If the headlight bulb is burnt, tilt hood.

Remove the rubber boot and turn bulb retainer ring counterclockwise.



A31E0BA

RUBBER BOOT AND BULB RETAINER REMOVAL

Pull off bulb retainer, detach the bulb and replace. Properly reinstall parts.



Taillight

Taillight is sealed. If it is burnt, replace taillight ass'y with new one.

To remove, unscrew the 2 lens screws.

Pull out taillight ass'y.

Unplug connector.

Install new taillight ass'y.

STORAGE

It is during summer, or when a snowmobile is not in use for more than one month that proper storage is a necessity.

To prepare your snowmobile, follow the lubrication and maintenance chart shown on page 68.

NOTE: All troubleshooting should be done by an adult or by an authorized Ski-Doo dealer.

TROUBLESHOOTING

SYMPTOM: <i>Engine turns over but fails to start</i>	
Possible causes	What to do
1. Ignition switch, emergency cut-out switch or tether switch is in the OFF position.	Place all switches in the RUN or ON position.
2. Mixture not rich enough to start cold engine.	Check fuel tank level and check starting procedure, particularly use of the choke.
3. Flooded engine (spark plug wet when removed).	Do not choke. Remove wet spark plug, turn ignition switch to OFF and crank engine several times. Install clean dry spark plug. Start engine following usual starting procedure. If engine continues to flood, see an authorized dealer.
4. No fuel to the engine (spark plug dry when removed).	Check fuel tank level; turn fuel valve on, check condition of fuel and impulse lines and their connections. A failure of the carburetor has occurred. Contact an authorized dealer.
5. Spark plug/ignition (no spark).	Remove spark plug then reconnect to spark cap. Check that emergency cut-out switch is at the ON position and the tether cut-out switch cap is snapped over the receptacle. Start engine with spark plug grounded to engine away from spark plug hole. If no spark appears, replace spark plug. If trouble persists, contact an authorized dealer.

SYMPTOM: Engine lacks acceleration or power

Possible causes	What to do
1. Fouled or defective spark plug.	Check item 5 of "Engine turns over but fails to start".
2. Lack of fuel to engine.	Check item 4 of "Engine turns over but fails to start".
3. Carburetor adjustments.	Contact an authorized dealer.
4. Clutch requires servicing.	Contact an authorized dealer.
5. Engine is overheating.	Clean cooling fins of engine; if overheating persists, contact an authorized dealer.

SYMPTOM: Engine backfire

Possible causes	What to do
1. Faulty spark plug (carbon accumulation).	See item 5 of "Engine turns over but fails to start".
2. Engine is running too hot.	See item 5 of "Engine lacks acceleration or power".
3. Ignition timing is incorrect or there is an ignition system failure.	Contact an authorized dealer.

SYMPTOM: Engine misfire

Possible causes	What to do
1. Fouled/defective/worn spark plug.	Clean/verify spark plug and heat range. Replace as required.
2. Water in fuel.	Drain fuel system and refill with fresh fuel.

SYMPTOM: Snowmobile cannot reach full speed

Possible causes	What to do
1. Incorrect track adjustment.	See Repair and Maintenance section and/or dealer for proper alignment and tension adjustments.
2. Engine.	See items 1, 2 and 5 of "Engine lacks acceleration or power".

SPECIFICATIONS

GENERAL		MINI Z
Engine		
– Maximum power engine speed	RPM	4000
Drive chain		
– Number		412 107 500
– Pitch	mm (in)	12.7 (0.500)
– Number of links		78
Spark plug		
– Type		NGK BPR6 ES
– Gap	mm (in)	0.7 - 0.8 (0.028 - 0.031)
Track		
– Number		570 211 900
– Tension	mm (in)	35 (1-3/8) ①
– Alignment		②
FLUIDS		
Fuel		
– Type		③
– Tank capacity	L (US gal)	1.8 (0.5)
Oil (engine)		
– Type		④
– Capacity	L (US oz)	0.6 (20.3)







Bombardier Inc. reserves the right at any time to discontinue or change specifications, designs features, models or equipment without incurring obligation.





- ① Measure gap between slider shoe and bottom inside of track when exerting a downward pull of 7.3 kg (16 lb) to the track.
- ② Equal distance between edges of track guides and slider shoes.
- ③ Regular unleaded gasoline with a minimum octane number of 86 (R + M)/2.
- ④ SAE 5W/30 4-stroke motor oil.

LUBRICATION AND MAINTENANCE CHART

Refer to LUBRICATION and MAINTENANCE section of *Shop Manual* for more details.

- ① 10-HOUR INSPECTION (to be performed by dealer)
- ② WEEKLY
- ③ MONTHLY
- ④ ONCE A YEAR
- ⑤ STORAGE (to be performed by dealer)
- ⑥ PRE-SEASON PREPARATION (to be performed by dealer)

LUBRICATION AND MAINTENANCE CHART		①	②	③	④	⑤	⑥
	Starting Rope Condition						✓
	Engine Head Nuts	✓			✓		
	Engine Mount Nuts	✓			✓		
	Exhaust System	✓		✓			✓
	Engine Lubrication					✓	
	Cooling System Condition	✓			✓		✓
	Condition of Seals						✓
	Valve Clearance				✓		
	Oil Level	EACH USE					
	Oil Change	✓	6 months/100 hr				
	Fuel Filter Replacement						✓
	Fuel Lines and Connections	✓					✓
	Carburetor Adjustment	✓			✓		✓
	Throttle Cable Inspection	✓			✓		✓
	Condition of Drive and Driven Gear	✓		✓		✓	✓
	Lubrication of Clutch and Chain	✓		✓		✓	✓
	Retorquing of Clutch Retaining Screw	✓		✓		✓	✓
	Brake Condition	✓	✓				✓
	Brake Adjustment			✓			✓

LUBRICATION AND MAINTENANCE CHART		①	②	③	④	⑤	⑥
	Drive Chain Tension	✓		✓			
	Lubrication of Drive Axle and Bearing			✓		✓	
	Steering and Front Suspension Mechanism	✓		✓		✓	✓
	Wear and Condition of Skis and Runners	✓	✓				
	Suspension Lubrication			✓		✓	
	Suspension Condition	✓			✓		✓
	Suspension Stopper Straps Condition				✓		✓
	Track Condition	✓		✓			✓
	Track Tension and Alignment	✓	AS REQUIRED				
	Spark Plug*	✓		✓			✓
	Engine Timing	✓					✓
	Headlight Beam Aiming				✓		
	Wiring Harnesses, Cables and Lines	✓		✓			
	Operation of Lighting System (headlight and taillight), Test Operation of Emergency Cut-Out Switch and Tether Cut-Out Switch	✓	✓				✓
	Rags in Air Intake and Exhaust System					✓	✓
	Engine Compartment	✓		✓			✓
	General Inspection	✓		✓		✓	

* Before installing new spark plug at pre-season preparation, it is suggested to burn excess storage oil by starting the engine with the old spark plug. Only perform this operation in a well ventilated area.

CHANGE OF ADDRESS OR OWNERSHIP

If your address or owner has changed, be sure to fill out and mail the card provided on next page.

Such notification is likewise necessary for your own safety even after expiration of the original warranty, since Bombardier will be in a position to contact you if correction to your snowmobile becomes necessary.

NOTICE TO ALL NEW OWNERS:

Make sure to receive the warranty registration card from the previous owner, when the ownership is transferred, as you are entitled to the unexpired portion of the warranty.

STOLEN UNITS

If the event that your snowmobile is stolen, you should notify your dealer and the Bombardier warranty department of such.

Please provide your name, address, phone number, vehicle serial number and date it was stolen.

Bombardier will provide a list of stolen units to all SKI-DOO dealers on a monthly basis to aid in recovery of such units to their owners.



CHANGE OF ADDRESS

CHANGE OF OWNERSHIP

VEHICLE IDENTIFICATION NUMBER

<input type="text"/>	<input type="text"/>	<input type="text"/>	<input type="text"/>
----------------------	----------------------	----------------------	----------------------

<input type="text"/>	<input type="text"/>	<input type="text"/>	<input type="text"/>
----------------------	----------------------	----------------------	----------------------

OLD ADDRESS
OR PREVIOUS OWNER:

NAME

NO

STREET

APT.

CITY

STATE/PROVINCE

ZIP/POSTAL CODE

NEW ADDRESS
OR NEW OWNER:

NAME

NO

STREET

APT.

CITY

STATE/PROVINCE

ZIP/POSTAL CODE

AFFIX
PROPER
POSTAGE

BOMBARDIER
Recreational Products
Ski-Doo Warranty
Valcourt (Quebec)
Canada J0E 2L0



®*Trademarks of Bombardier Inc.
© 1999 Bombardier Inc. All rights Reserved
Litho'd in Canada



BOMBARDIER
RECREATIONAL PRODUCTS

