

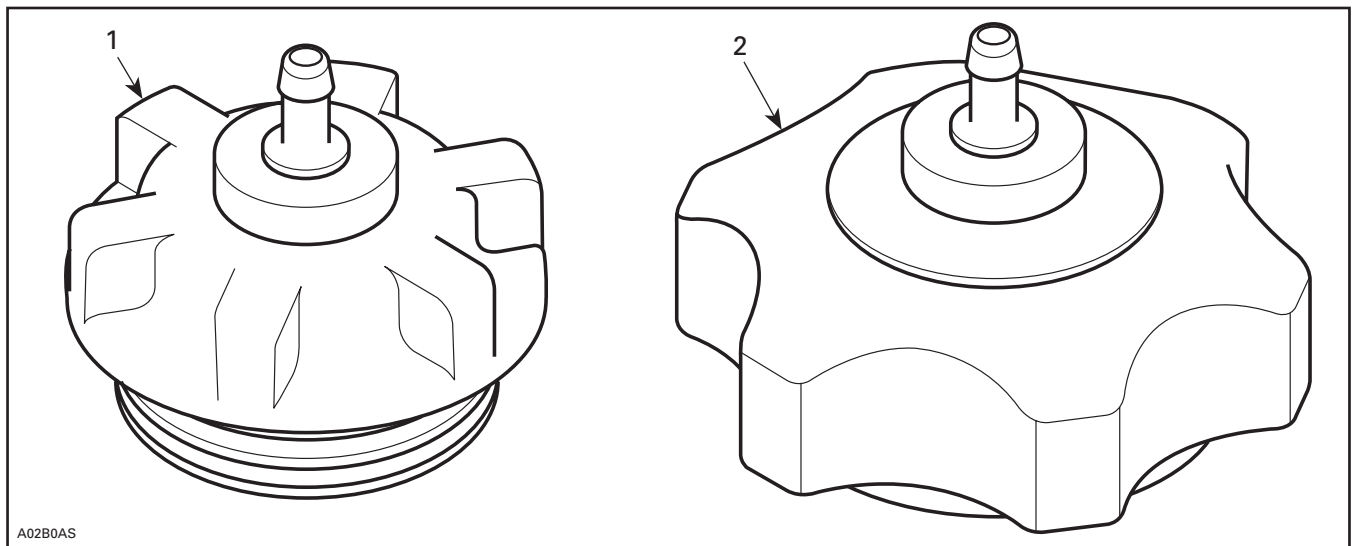

◆ **WARNING**

For safety reasons, this kit must be installed by an authorized Bombardier snowmobile dealer. Should removal of a locking device be required when undergoing disassembly/assembly, always replace with a new one. This instruction sheet should be given to the purchaser. This kit is designed for specific applicable models only. It is not recommended for units other than those for which it was sold.

PARTS TO BE INSTALLED



A02B0AS

1. Oil Cap Assembly
2. Fuel Cap Assembly

INSTRUCTION

Fuel System

All Models

The following test will indicate any leak from fuel tank to carburetor(s).

Fill up fuel tank.

Install on fuel tank special cap **no. 2**.

Install hose pinchers (P/N 295 000 076) on fuel tank vent line and fuel pump outlet hose at carburetor(s).

Tundra Series Only

Install a hose pincher (P/N 295 000 076) on primer outlet hose.

NOTE: To verify leaks up to carburetor fitting, install hose pincher on primer outlet hose near carburetor.

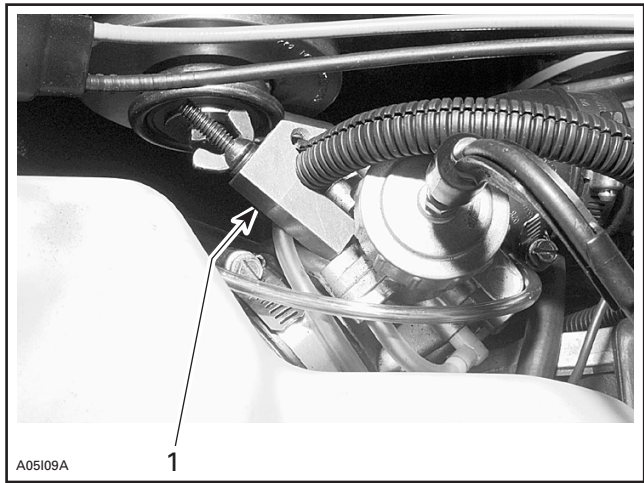

TUNDRA SERIES

1. Hose pincher on fuel pump outlet hose

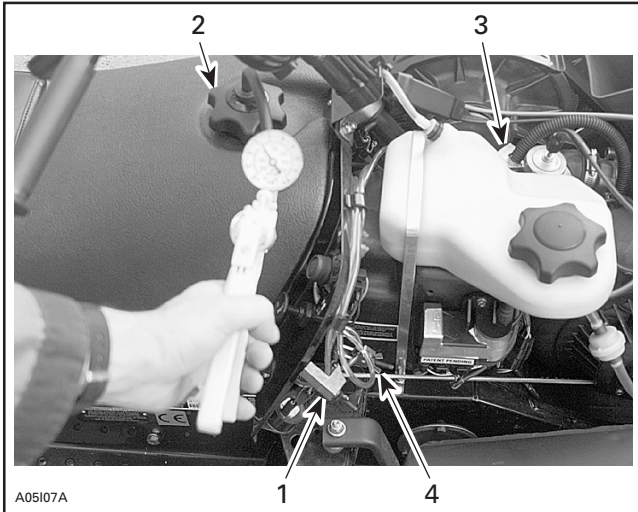

TUNDRA SERIES

1. Hose pincher on fuel tank vent line
2. Special cap on tank
3. Hose pincher on fuel pump outlet hose
4. Hose pincher on primer outlet hose

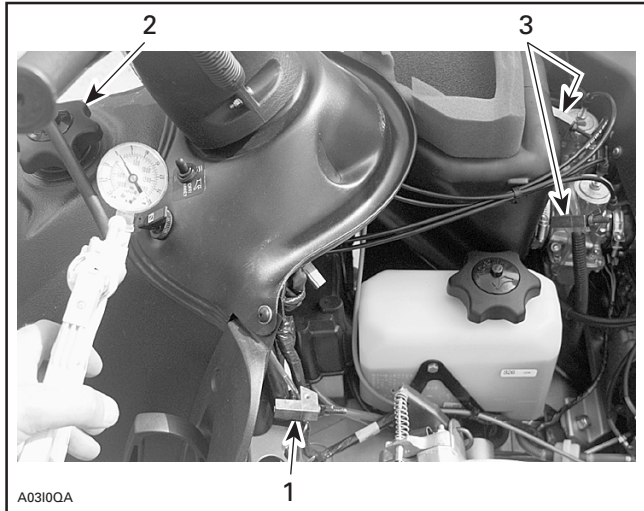

S-SERIES

1. Hose pincher on fuel tank vent line
2. Special cap on tank
3. Hose pinchers on fuel pump outlet hoses

All Models

Using air pump from engine leak test kit (P/N 861 749 100) inject air into fuel tank.

Pressurize fuel system to 21 kPa (3 PSI). That pressure must not drop during 3 minutes.

If pressure drops, locate leak(s) and repair/replace leaking component(s). To ease locating leak(s) spray soapy water on components, bubbles will indicate leak location(s).

Oil System

All Models

The following test will indicate any leak from oil reservoir to the banjo fitting(s).

Install on oil reservoir special cap **no. 1**.

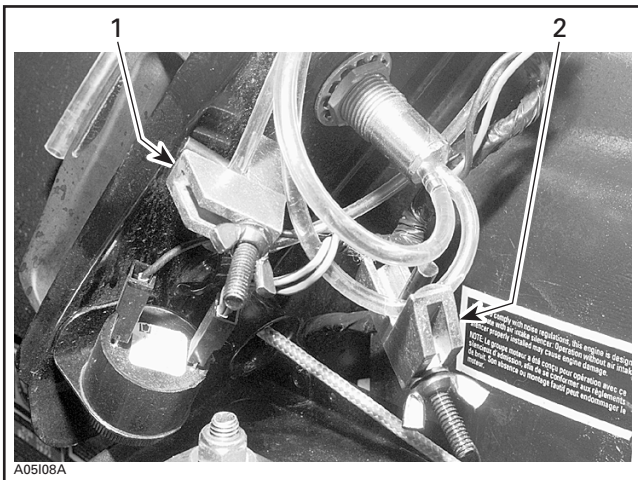

TUNDRA SERIES

1. Hose pincher on fuel tank vent line
2. Hose pincher on primer outlet hose

Tundra Series

Install hose pinchers (P/N 295 000 076) on oil reservoir vent line and outlet hose.

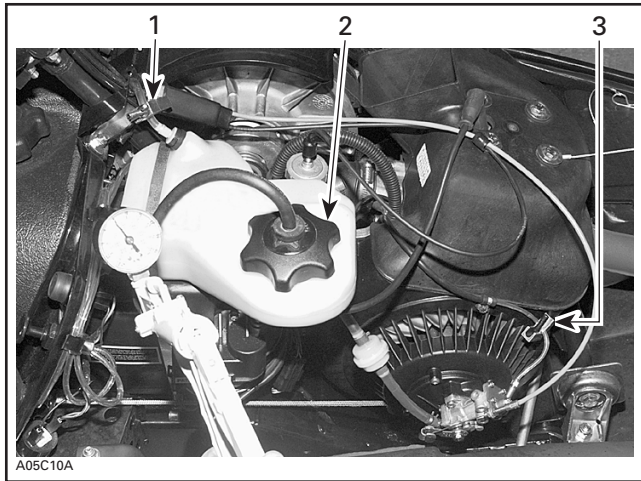

TUNDRA SERIES

1. Hose pincher on vent line
2. Special cap on reservoir
3. Hose pincher on outlet hose

S-Series

Install hose pinchers (P/N 295 000 076) on outlet hoses.

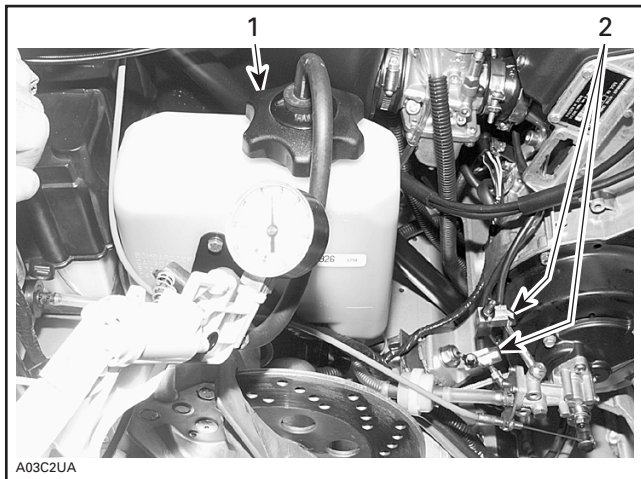

S-SERIES

1. Special cap on reservoir
2. Hose pinchers on outlet hoses

All Models

Connect air pump from engine leak test kit (P/N 861 749 100) to special cap.

Pressurize oil system to 34 kPa (5 PSI). That pressure must not drop during 3 minutes.

If pressure drops, locate leak(s) and repair/replace leaking component(s). To ease locating leak(s) spray soapy water on components, bubbles will indicate leak location(s).

529 033 100

1.	529 033 102	Oil Cap Assembly	Bouchon de remplissage d'huile (complet)
2.	529 033 103	Fuel Cap Assembly	Bouchon de réservoir de carburant (complet)