

# SERVICE TOOLS

This is a list of tools to properly service Ski-Doo snowmobiles. The list includes both the mandatory tools included in a kit (P/N 861 743 700) and the optional tools that are ordered separately. The list of Service Products, both mandatory and optional, are not part of any kit and must all be ordered separately. If you need to replace or add to your tool inventory these items can be ordered through the regular parts channel.

Following mention points out new tool:



---

## Section 01 SERVICE TOOLS AND SERVICE PRODUCTS

### Subsection 01 (SERVICE TOOLS)

---

## WORKSHOP — MANDATORY SERVICE TOOLS

Tool board

(P/N 529 034 000)

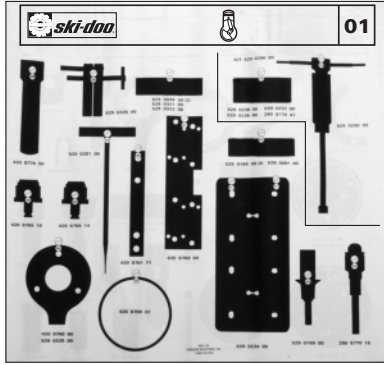

A00A3X4

### APPLICATION

All models.

# Section 01 SERVICE TOOLS AND SERVICE PRODUCTS

## Subsection 01 (SERVICE TOOLS)

### ENGINE — MANDATORY SERVICE TOOLS

Degree wheel  
(P/N 295 000 007)

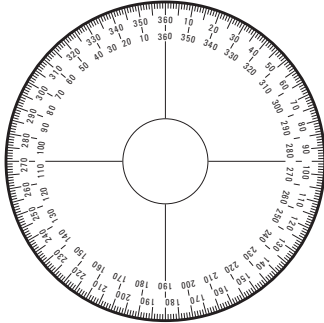

A00B514

#### APPLICATION

All rotary valve engines.

**NOTE:** Only the P/N has been changed. This degree wheel is identical to the P/N 414 352 900.

Hose pincher (2)  
(P/N 295 000 076)

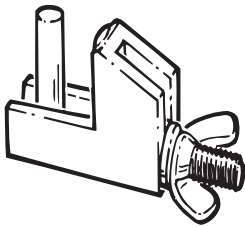

A01B214

#### APPLICATION

All vehicles.

**NOTE:** Only the P/N has been changed. This hose pincher is identical to the P/N 529 009 900.

Fan holder  
(P/N 420 876 357)

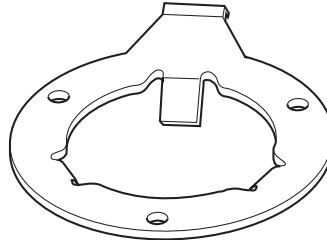

A00C0Q4

#### APPLICATION

377, 443 and 503 engines.

Magneto puller ring  
(P/N 420 876 080)

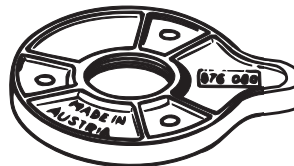

A00C1R4

#### APPLICATION

All engines except 247.

Magneto puller  
(P/N 529 033 547)

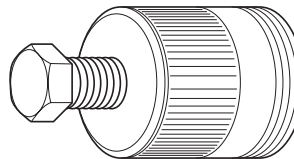

A00C1A4

#### APPLICATION

All engines except 247.

**NOTE:** The previous extractor (P/N 529 022 500) can be upgraded by replacing the screw with the new one (P/N 529 035 549).

Aligning pin (4)  
(P/N 529 018 900)

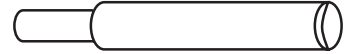

A00A1D4

#### APPLICATION

467, 494 and 582 engines.

Pusher  
(washer behind the impeller)  
(P/N 529 020 700)

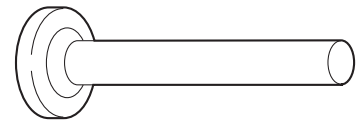

A00C3H4

#### APPLICATION

Rotary valve engines.

Rotary valve shaft pusher  
(P/N 420 876 612)



A00C0F4

#### APPLICATION

Rotary valve engines with a 10 mm impeller shaft.

Rotary valve seal pusher  
(valve side)  
(P/N 420 876 607)

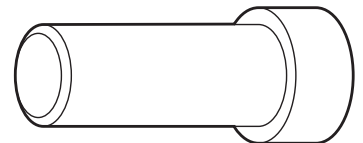

A00C0Y4

#### APPLICATION

Rotary valve engines.

## Section 01 SERVICE TOOLS AND SERVICE PRODUCTS

### Subsection 01 (SERVICE TOOLS)

## ENGINE (continued) — MANDATORY SERVICE TOOLS

Rotary valve shaft seal pusher  
(inner, water pump side)  
(P/N 420 876 512)



A00C374

#### APPLICATION

Rotary valve engines, 1991 and newer with a 10 mm impeller shaft.

Rotary valve shaft seal pusher  
(outer, water pump side)  
(P/N 420 877 050)

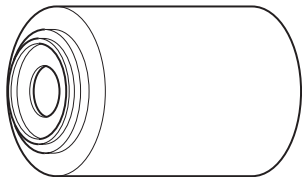

A00C0X4

#### APPLICATION

Rotary valve engines.

Bearing pusher  
(rotary valve)  
(P/N 420 876 500)

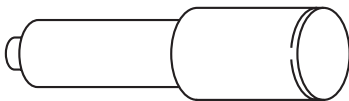

A00B2J4

#### APPLICATION

Rotary valve engines.

Engine leak tester kit  
(P/N 861 749 100)

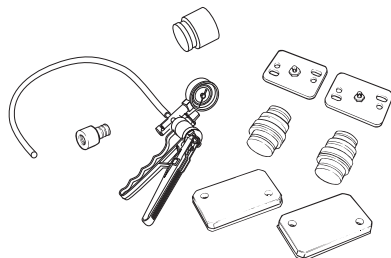

A01B2D5

#### APPLICATION

All engines.

Fuel and oil system leak tester kit  
(P/N 529 033 100)



A01B5E4

#### APPLICATION

All models.

Choke plunger tool  
(P/N 529 032 100)

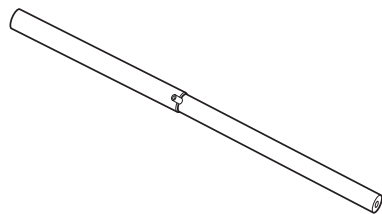

A01C5D4

#### APPLICATION

All models equipped with chokes except ZX series.

1) Piston pin puller  
(P/N 529 035 503)

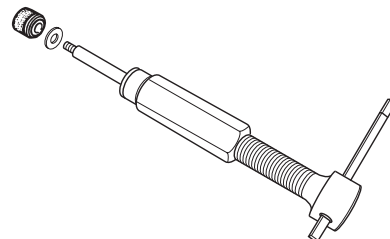

A02B094

2) Sleeve kit 18 mm  
(P/N 529 035 541)

3) Sleeve kit 20 mm  
(P/N 529 035 542)

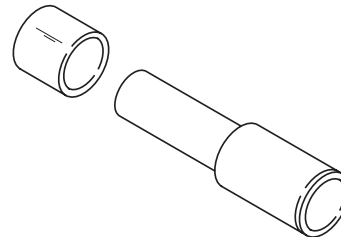

A01B5A4

#### APPLICATION

- 1) All engines.
- 2) 277, 443, 503 and 809 engine.
- 3) 670 engine.

**NOTE:** The previous piston pin puller (P/N 529 029 000) can be upgraded by adding protector (P/N 529 035 513) and replacing the locating sleeve and expansion sleeve with appropriate sleeve kit.

Rubber pad  
(P/N 529 023 400)

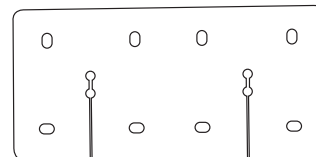

A01B4C4

#### APPLICATION

All cageless bearing engines.

## Section 01 SERVICE TOOLS AND SERVICE PRODUCTS

### Subsection 01 (SERVICE TOOLS)

## ENGINE (continued) — MANDATORY SERVICE TOOLS

Rotary valve circlip tool

A) (P/N 529 029 100)

B) (P/N 529 020 800)

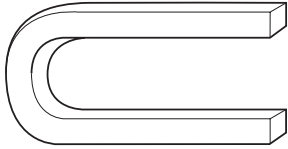

A00C314

#### APPLICATION

A) 1994 and on rotary valve engines.

B) Up to 1993 rotary valve engines.

Choke/DESS nut tool

(P/N 529 034 600)

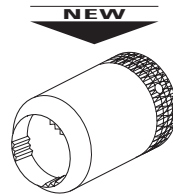

A01B554

#### APPLICATION

All models equipped with a choke and/or a DESS.

**NOTE:** This tool replaces choke nut tool (P/N 529 032 200).

Multimeter

(P/N 529 022 000)

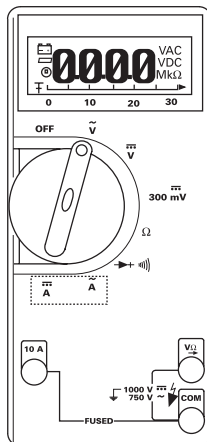

F01B104

#### APPLICATION

All models.

Programmer

(P/N 529 035 589)



A01B5B4

#### APPLICATION

All models equipped with a DESS.

## Section 01 SERVICE TOOLS AND SERVICE PRODUCTS

### Subsection 01 (SERVICE TOOLS)

## ENGINE (continued) — RECOMMENDED SERVICE TOOLS

The following tools are highly recommended to optimize your basic tool kit and reduce repair time.

1-2) Crankshaft bearing puller with screw  
(P/N 420 877 635)

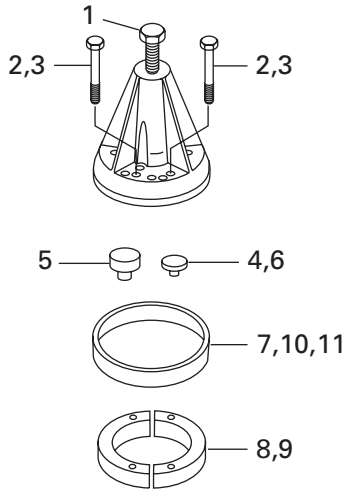

A01B546

#### APPLICATION

All engines.

1) Screw (M16 x 1.5 x 150)	(P/N 420 940 755)
2) Screw M8 x 40 (4)	(P/N 420 840 681)
3) Screw M8 x 70 (4)	(P/N 420 841 201)
4) Crankshaft protector 247 engine.	(P/N 420 976 890)
5) Crankshaft protector PTO All engines except 247.	(P/N 420 876 552)
6) Crankshaft protector MAG All engines except 247.	(P/N 420 876 557)
7) Puller ring Use with half rings (P/N 420 977 475 or 420 276 025).	(P/N 420 977 490)
8) Half ring (2) For 72 mm O.D. bearings.	(P/N 420 977 475)
9) Half ring For 62 mm O.D. bearings.	(P/N 420 276 025)
10) Puller ring For half rings (P/N 420 977 479).	(P/N 420 977 494)
11) Half ring For 80 mm O.D. bearings.	(P/N 420 977 479)

## Section 01 SERVICE TOOLS AND SERVICE PRODUCTS

### Subsection 01 (SERVICE TOOLS)

## ENGINE (continued) — RECOMMENDED SERVICE TOOLS

Piston circlip installer

- A) (P/N 529 035 561) 18 mm
- B) (P/N 529 035 562) 20 mm



A00B4Y4

#### APPLICATION

A) All engines except 670.

**NOTE:** This tool replaces circlip installer (P/N 529 016 900).

B) 670 engine.

**NOTE:** This tool replaces circlip installers (P/N 529 035 562 and 290 877 016).

Ring compressor

- A) (P/N 420 876 090) (62 mm)
- B) (P/N 420 876 974) (69.5 mm)
- C) (P/N 420 876 970) (72 mm)
- D) (P/N 420 876 972) (76 mm)
- E) (P/N 420 876 975) (67.5 mm)
- F) (P/N 529 030 800) (78 mm)

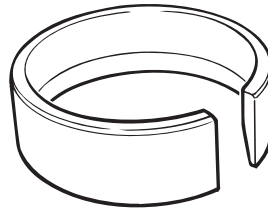

A01B1T4

#### APPLICATION

A) 377 engine.

B) 467 and 494 engines.

C) 503, 253 and 536 engines.

D) 582, 583 and 643 engines.

E) 443 and 447 engines.

F) 670 engine.

Magneto coil centering ring  
(P/N 420 876 922)

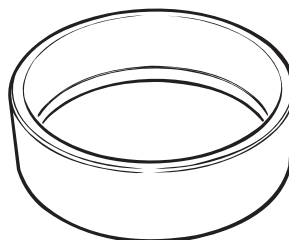

A01B1V4

#### APPLICATION

All engines with Nippondenso CDI (160 W).

Seal protector sleeve

(P/N 420 276 900)  
(MAG)

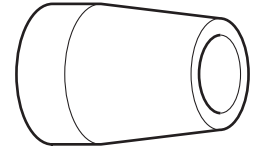

A00C0D4

#### APPLICATION

247 engine.

Polyamid ring pusher

(P/N 420 276 930)

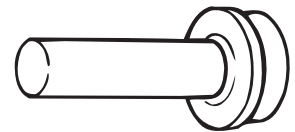

A00C0Z4

#### APPLICATION

247 engine.

Piston pin/connecting  
rod bearing centering tool  
(P/N 529 009 100)

**NOTE:** New diameter is 9.65 mm  
(0.380 in).

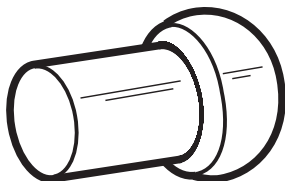

A01B1R4

#### APPLICATION

All engines except cageless and 670 engines.

Crankshaft feeler gauge

(P/N 420 876 620)

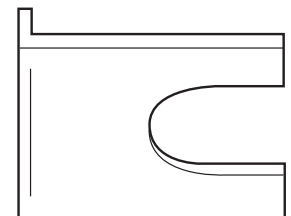

A00C114

#### APPLICATION

377, 443, 447 and 503 engines.

## Section 01 SERVICE TOOLS AND SERVICE PRODUCTS

### Subsection 01 (SERVICE TOOLS)

## ENGINE (continued) — RECOMMENDED SERVICE TOOLS

Crankshaft distance gauge (5.7 mm)  
(P/N 420 876 822)

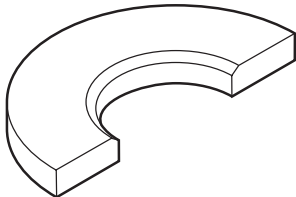

A00C294

#### APPLICATION

377, 443 and 447 engines.

Crankshaft distance gauge (12.7 mm)  
(P/N 420 876 824)

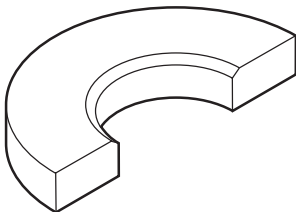

A00C3A4

#### APPLICATION

503 engine.

Cylinder aligning tool

A) (P/N 420 876 904)  
(on exhaust side)

B) (P/N 420 876 171)  
(on intake side)



A00B084

#### APPLICATION

A) 2-cylinder liquid cooled engines.

B) 2-cylinder fan cooled engines.

Driver tool  
(P/N 529 035 521)

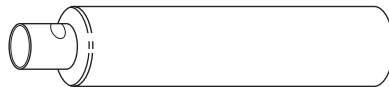

A00B4Q4

#### APPLICATION

Mini Z.

Attachment  
(P/N 529 035 522)

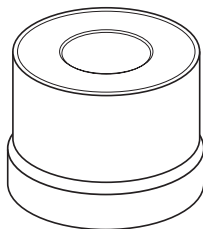

A00B4P4

#### APPLICATION

Mini Z.

Pilot 22 mm  
(P/N 529 035 523)

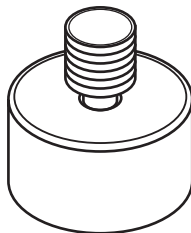

A00B4Q4

#### APPLICATION

Mini Z.

Carburetor tool kit  
(P/N 404 112 000)

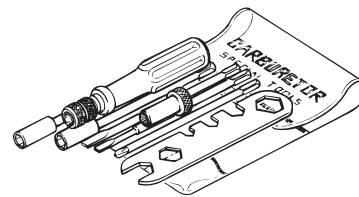

A00B2F4

#### APPLICATION

All models.

Adaptor  
(P/N 529 033 800)  
(TYPICAL)



A00B4H4

#### APPLICATION

1997 and 1998 Grand Touring SE  
1998 Summit x 670.

Float level gauge  
(P/N 529 035 520)

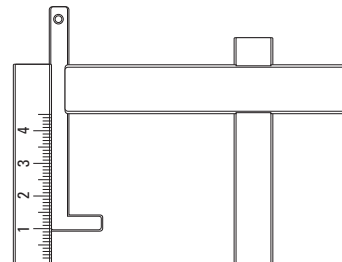

A00B4N4

#### APPLICATION

All models.



## Section 01 SERVICE TOOLS AND SERVICE PRODUCTS

### Subsection 01 (SERVICE TOOLS)

## ENGINE (continued) — RECOMMENDED SERVICE TOOLS

Circuit tester  
(continuity light)  
(P/N 414 012 200)

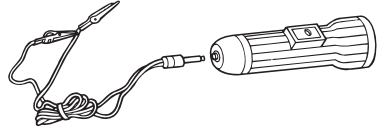

A00C214

#### APPLICATION

All vehicles.

RAVE movement indicator  
(P/N 861 725 800)

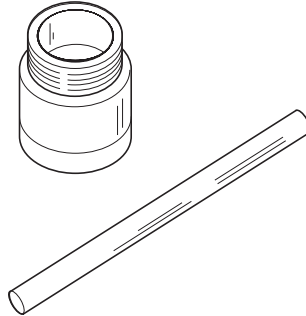

A18B014

#### APPLICATION

All RAVE equipped engines.

Magneto puller  
(P/N 420 976 235)

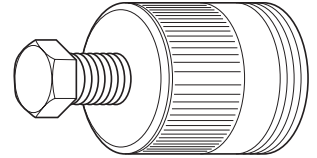

A00C1A4

#### APPLICATION

247 engine.

Stroboscopic timing light  
(P/N 529 031 900)



A00B4F4

#### APPLICATION

All engines.

Dial indicator  
(TDC gauge)  
(P/N 414 104 700)

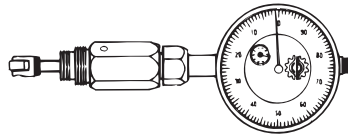

A00B4E4

#### APPLICATION

All engines.

Injection pump gear holder  
(P/N 420 876 695)

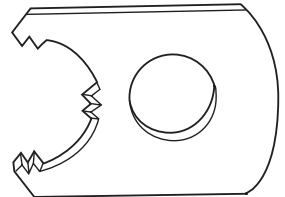

A00B314

#### APPLICATION

253, 377, 447 and 503 engines.

Bypass wires  
(P/N 529 033 300)



A00I094

#### APPLICATION

360 W magneto  
(Grand Touring 700/SE).

Seal protector sleeve  
A) (P/N 420 876 980)  
B) (P/N 420 876 490)

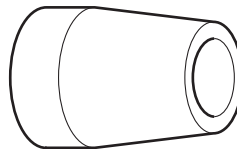

A00COD4

#### APPLICATION

A) Rotary valve engines with 10 mm shaft.  
B) Rotary valve engines with 12 mm shaft.

Injection pump gear holder  
(P/N 420 277 905)

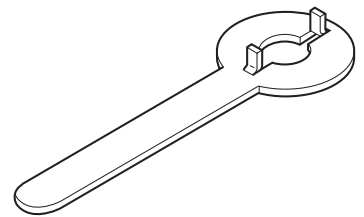

A00C164

#### APPLICATION

All liquid cooled engines.

# Section 01 SERVICE TOOLS AND SERVICE PRODUCTS

## Subsection 01 (SERVICE TOOLS)

### ENGINE (continued) — RECOMMENDED SERVICE TOOLS

Digital/induction type tachometer  
(P/N 529 014 500)

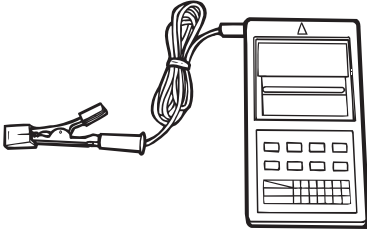

F01B1G4

**APPLICATION**  
All engines.

Base puller plate kit  
(P/N 529 024 900)

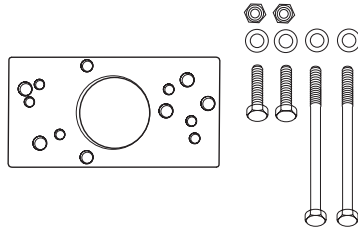

A05C0M4

**APPLICATION**  
277 engine.

Handle for insertion jig  
(P/N 420 877 650)

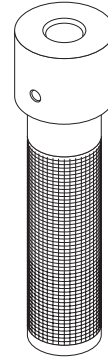

A00C3V4

**APPLICATION**  
454, 494, 599, 670, 699, 779 and 809 engines.

MAG seal pusher  
(P/N 420 277 875)

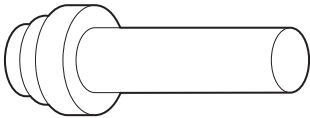

A00C0V4

**APPLICATION**  
277 engine.

Insertion jig  
(magneto side seal)  
(P/N 420 876 516)

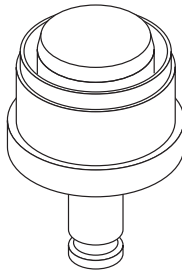

A00C3T4

**APPLICATION**  
779 engine.

PTO seal pusher  
(P/N 420 876 660)

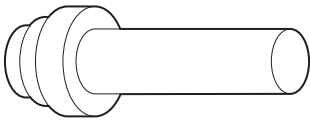

A00C0V4

**APPLICATION**  
277 engine.

Insertion jig  
(magneto seal)  
(P/N 420 876 514)

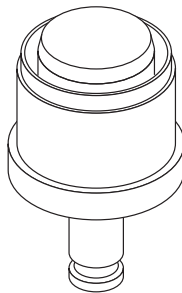

A00C3U4

**APPLICATION**  
454, 494, 599, 670, 699 and 809 engines.

Exhaust spring installer/remover  
(P/N 529 035 559)

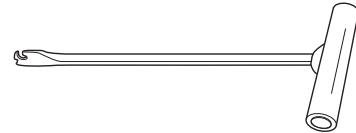

A00C3S4

**APPLICATION**  
All models except CK3 series.  
**NOTE:** This tool replaces exhaust spring installer/remover (P/N 529 028 100).

Exhaust spring installer/remover  
(P/N 529 035 400)

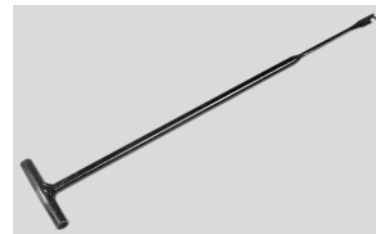

A01B584

**APPLICATION**  
CK3 series.

**Section 01 SERVICE TOOLS AND SERVICE PRODUCTS**

Subsection 01 (SERVICE TOOLS)

**ENGINE (continued) — RECOMMENDED SERVICE TOOLS**

Rotary valve seal and shaft pusher  
(P/N 420 876 605)

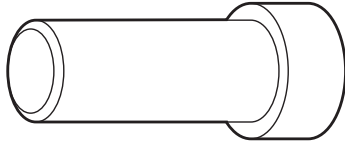

A00C0Y4

**APPLICATION**

Rotary valve engines 1990 models and older.

Seal pusher (rotary valve)  
(P/N 420 876 510)



A00C374

**APPLICATION**

All rotary valve shaft seals with a 12 mm I.D.

Rotary valve shaft pusher  
(P/N 420 876 610)



A00C0F4

**APPLICATION**

All rotary valve engines with 12 mm shaft.

Large hose pincher  
(P/N 529 032 500)  
(TYPICAL)

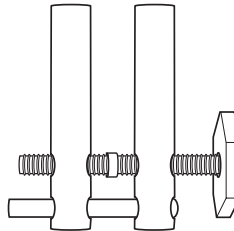

F01B234

**APPLICATION**

All vehicles.

## Section 01 SERVICE TOOLS AND SERVICE PRODUCTS

### Subsection 01 (SERVICE TOOLS)

## TRANSMISSION — MANDATORY SERVICE TOOLS

Transmission alignment bar

- A) (P/N 529 026 900)
- B) (P/N 529 030 000)
- C) (P/N 529 026 700)
- D) (P/N 529 035 530)
- E) (P/N 529 035 545)
- F) (P/N 529 031 000)
- G) (P/N 529 035 527)
- H) (P/N 529 035 572)



A01B4D4

#### APPLICATION

- A) Tundra II LT/R.
- B) S-Series with Bombardier Lite.
- C) F-Series and S-Series with TRA.
- D) S-Series with TRA and RER.
- E) Skandic WT.
- F) Skandic WT LC/SWT.
- G) CK3 series except Mach Z series.
- H) Mach Z series.

Drive belt tension adjuster tool  
(P/N 529 008 700)

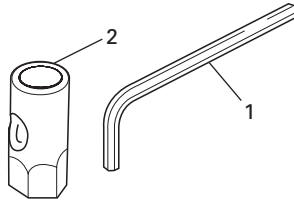

A15B044

#### APPLICATION

All vehicles except Élan, Tundra II and Skandic WT.

Parts included:

- 1) Hex. wrench  
(P/N 420 876 730)
- 2) Socket wrench  
(P/N 529 015 000)

Driven pulley spring compressor  
(P/N 529 035 300)



A05B034

#### APPLICATION

Tundra R.

Tension tester

(P/N 414 348 200)



A00C074

#### APPLICATION

All models.

Spring scale hook (long)

- A) (P/N 529 006 500)
  - B) (P/N 529 030 900)
  - C) (P/N 529 035 557)
- (TYPICAL)

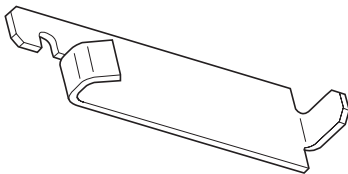

A00B4A4

#### APPLICATION

- A) Tundra II LT.
- B) F-Series and S-Series  
(1995 and newer).
- C) CK3 without RER.

Pulley spring compressor  
(P/N 529 035 524)

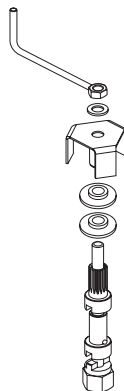

A02D1P4

#### APPLICATION

All models.

**NOTE:** This tool has Acme threads and replaces spring compressor (P/N 529 018 600).

Countershaft bearing installer  
(P/N 529 030 200)

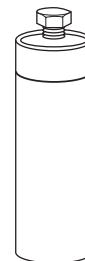

A00A194

#### APPLICATION

S-Series and F-Series.

**TRANSMISSION (continued) — MANDATORY SERVICE TOOLS**

Countershaft bearing remover  
(P/N 529 030 100)

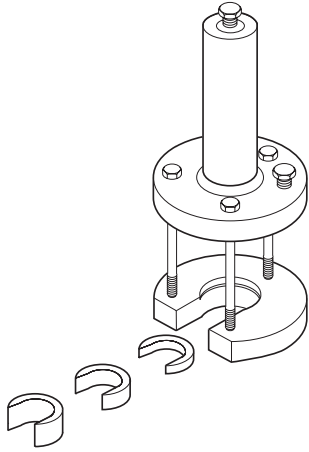

A00A274

**APPLICATION**

S-Series and F-Series.

Spring cover tool  
(P/N 529 027 300)

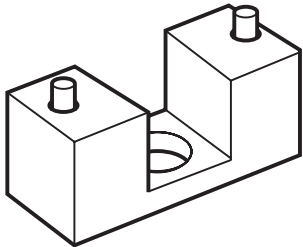

A01B4M4

**APPLICATION**

Bombardier Lite drive pulley.

## Section 01 SERVICE TOOLS AND SERVICE PRODUCTS

### Subsection 01 (SERVICE TOOLS)

## TRANSMISSION (continued) — RECOMMENDED SERVICE TOOLS

The following tools are highly recommended to optimize your basic tool kit and reduce repair time.

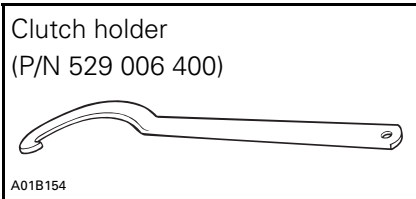

**APPLICATION**  
All TRA drive pulleys.

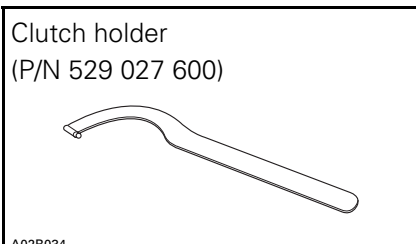

**APPLICATION**  
Bombardier Lite drive pulley.

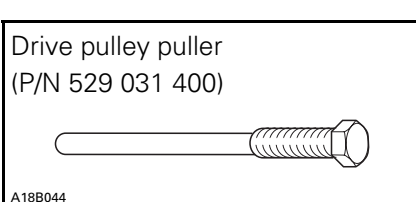

**APPLICATION**  
Bombardier Lite drive pulley, except Élan.

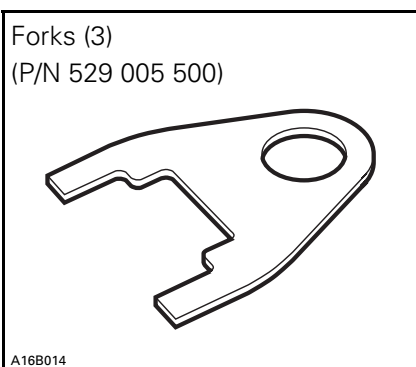

**APPLICATION**  
All vehicles equipped with a TRA drive pulley.

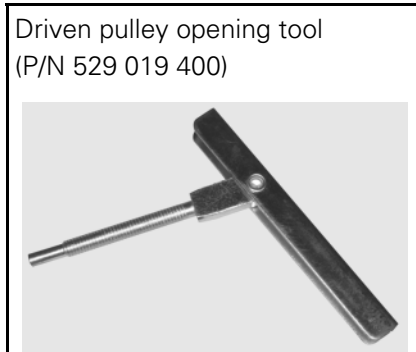

**APPLICATION**  
All vehicles except Élan, Tundra series, Skandic WT series and all vehicles with RER.



**APPLICATION**  
S and CK3 series with RER.



**APPLICATION**  
Tundra R.

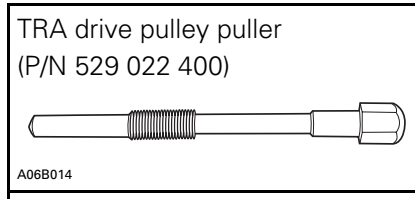

**APPLICATION**  
TRA drive pulley for the 454, 494, 599, 670, 699, 779 and 809 engines.

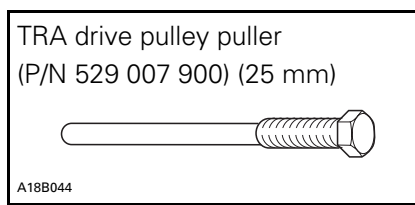

**APPLICATION**  
TRA drive pulley for 443 and 503 engines.

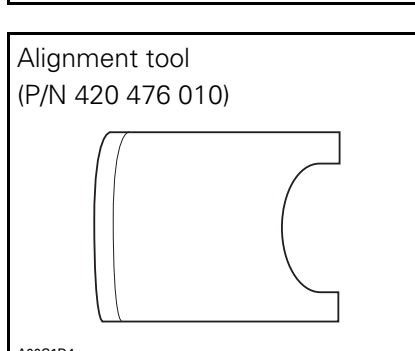

**APPLICATION**  
Skandic WT and Alpine II gearbox.



**APPLICATION**  
PRS chassis.

**Section 01 SERVICE TOOLS AND SERVICE PRODUCTS**

**Subsection 01 (SERVICE TOOLS)**

**TRANSMISSION (continued) — RECOMMENDED SERVICE TOOLS**

Cam pusher  
(P/N 529 012 900)

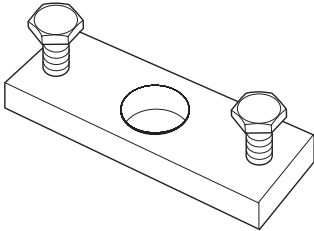

A18B064

**APPLICATION**  
Tundra II LT.

Drive pulley puller  
(P/N 529 023 100)

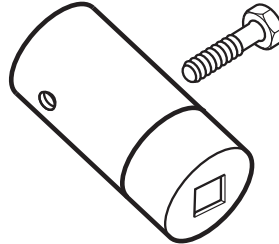

A00C3J4

**APPLICATION**  
Élan.

Spring scale hook (long)  
(P/N 529 015 200)

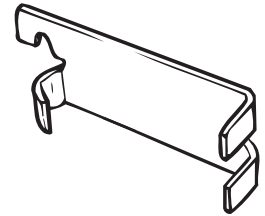

A01B514

**APPLICATION**  
1994 models and older except  
Alpine II.

Countershaft bearing remover  
(P/N 529 018 700)

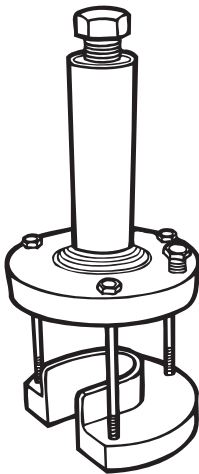

A00A164

**APPLICATION**  
PRS chassis.

Transmission ball mounting pin  
(P/N 420 476 020)



A00C1C4

**APPLICATION**  
Alpine II 3-speed gearbox.

Spring scale hook (short)  
(P/N 529 006 500)

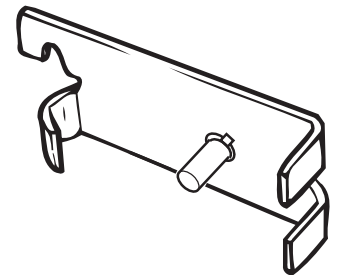

A01B174

**APPLICATION**  
Alpine II 1994 and older.

Transmission adjuster  
(P/N 529 028 500)

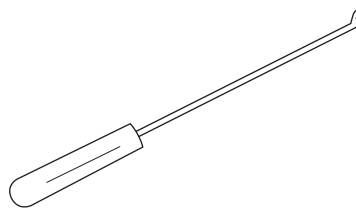

A00D0X4

**APPLICATION**  
F-Series equipped with "twist  
shifter" reverse transmission.

## Section 01 SERVICE TOOLS AND SERVICE PRODUCTS

### Subsection 01 (SERVICE TOOLS)

## TRANSMISSION (continued) — RECOMMENDED SERVICE TOOLS

Alignment bar

- A) (P/N 529 025 600)
- B) (P/N 529 028 200)
- C) (P/N 529 028 300)
- D) (P/N 529 026 800)
- E) (P/N 529 031 000)



A01B4D4

- F) (P/N 529 008 300)



A03B034

#### APPLICATION

- A) PRS chassis.
- B) Alpine II.
- C) Élan.
- D) Safari L.
- E) Skandic WT 1996.
- F) Scout.

Large bushing extractor  
(P/N 529 031 100)

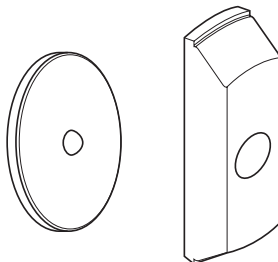

A00B414

#### APPLICATION

All models except Tundra/R, Skandic WT/SWT/WT LC and S-Series with RER.

**NOTE:** Use this tool only with former puller (P/N 529 018 600) that has regular threads.

Large bushing installer and small bushing extractor  
(P/N 529 031 200)

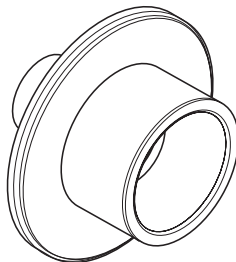

A00B4J4

#### APPLICATION

All models except Tundra/R, Skandic WT/SWT/WT LC and S-Series with RER.

3-speed transmission bearing extractor

- 1) Screw M8 x 25 (2)  
(P/N 222 082 565)
- 2) Plate
- 3) Half ring (2)  
(P/N 420 876 330)
- 4) Ring  
(P/N 420 977 480)

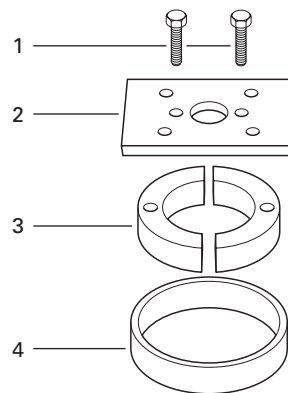

A00C1B4

#### APPLICATION

Alpine II 3-speed transmission.

Burnishing bar  
(P/N 529 026 402)

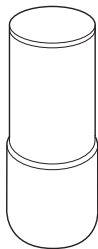

A00B464

#### APPLICATION

Tundra II LT, Safari L and Skandic.

Drive pulley puller  
(P/N 529 002 100)  
(standard threads)

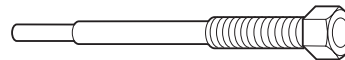

A00C084

#### APPLICATION

Square shaft, standard (SAE) threads.

TRA drive pulley puller (27 mm)  
(P/N 529 010 100)

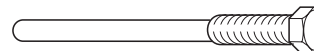

A18B044

#### APPLICATION

TRA drive pulley (27 mm) shaft except 454, 670 and 779 engines.



**TRANSMISSION (continued) — RECOMMENDED SERVICE TOOLS**

Drive pulley puller  
(P/N 860 414 200)  
(square shaft metric)

Consists of:

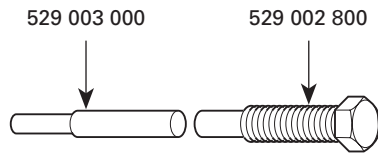

A00C095

**APPLICATION**

Square shaft, metric threads drive pulley.

Transmission adjuster  
(P/N 529 030 300)

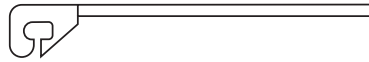

A03D1T4

**APPLICATION**

Vehicles equipped with "push-pull shifter" reverse transmission.

Drive axle sprocket adjuster  
(P/N 861 725 700)

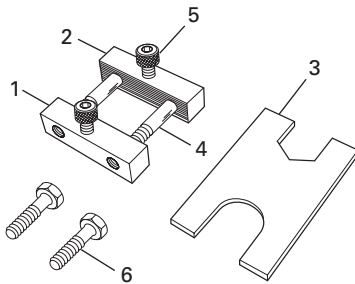

A01B204

**APPLICATION**

All vehicles except Élan.

Parts included in the kit:

- 1) Block with threads  
(P/N 529 010 700)
- 2) Block without threads  
(P/N 529 010 800)
- 3) Plate  
(P/N 529 010 600)
- 4) Bolt M10 (2)  
(P/N 222 007 565)
- 5) Allen screw M8 (2)  
(P/N 222 983 065)
- 6) Screw M8 (2)  
(P/N 222 082 565)

**NOTE:** When the tool is to be used between tunnel and sprocket use screws M8.

---

## Section 01 SERVICE TOOLS AND SERVICE PRODUCTS

### Subsection 01 (SERVICE TOOLS)

---

## SUSPENSION — MANDATORY SERVICE TOOLS

Shock spring removal kit

(P/N 529 035 504)

Replacement clevis pin:

(P/N 414 528 400)

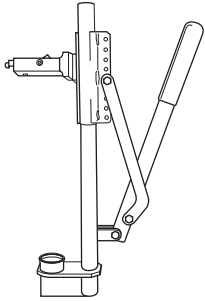

A01B404

#### APPLICATION

All suspensions with coil spring.

**NOTE:** The previous shock spring removal kit (P/N 529 027 100) can be upgraded by replacing the stopper with a wider stopper (P/N 529 035 551).

## Section 01 SERVICE TOOLS AND SERVICE PRODUCTS

### Subsection 01 (SERVICE TOOLS)

## SUSPENSION (continued) — RECOMMENDED SERVICE TOOLS

A) Track cleat remover  
(P/N 529 008 200)

Pins  
(P/N 529 008 204)

**NOTE:** Pins can be rotated 180° depending on whether the tool is used by a left-hander or right-hander.

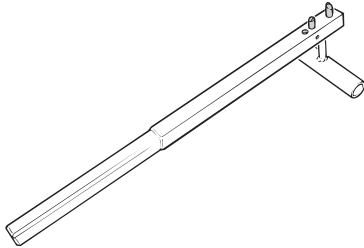

A01B1J4

B) Track cleat remover  
(P/N 529 028 700)

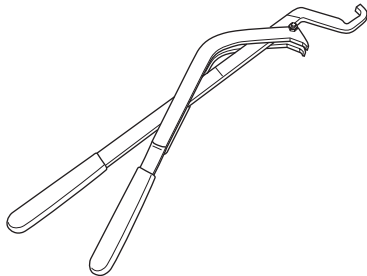

A01F224

#### APPLICATION

- A) 1993 and older.
- B) 1994 and newer except Élan and Tundra II.

Camber angle tool  
(P/N 529 021 600)

**NOTE:** Angle finder with a magnetic base must be used.

Suggestion: K-D tool no. 2968

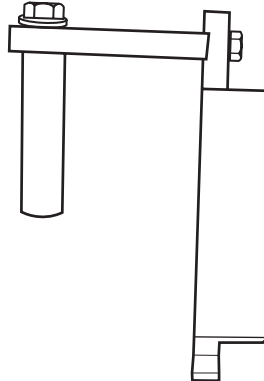

A06B024

#### APPLICATION

All DSA front suspensions.

Track tension gauge  
(P/N 529 021 500)

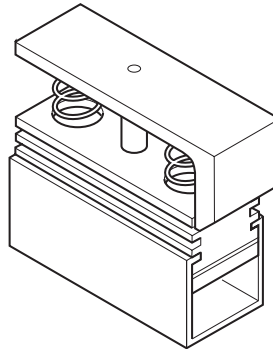

A00B3X4

#### APPLICATION

All models except Élan.

Track cleat installer

A) (P/N 529 008 500)

Narrow

B) (P/N 529 028 800)

Narrow

C) (P/N 529 007 700)

Wide

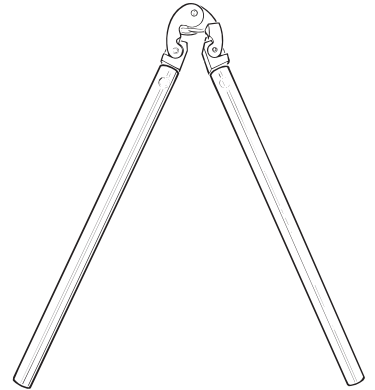

A01B1M4

#### APPLICATION

- A) 1993 and older.
- B) 1994 and newer.
- C) 1992 and older with wide cleat opening.

Dome guide

(P/N 529 026 500)



A06F1B4

#### APPLICATION

T/A shocks.

## Section 01 SERVICE TOOLS AND SERVICE PRODUCTS

### Subsection 01 (SERVICE TOOLS)

## SUSPENSION (continued) — RECOMMENDED SERVICE TOOLS

Piston guide  
(P/N 529 026 600)

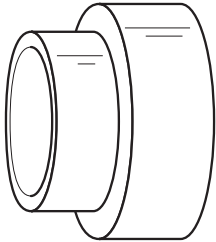

A06F1C4

#### APPLICATION

T/A shocks.

Spring installer (bar)  
(P/N 529 005 000)

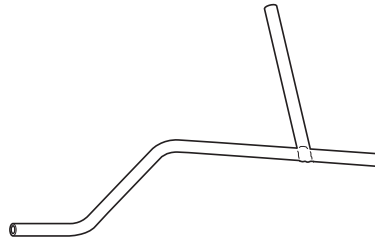

A00C114

#### APPLICATION

Tundra II LT, Scout and all SC-10 suspensions.

Hexagonal wrench  
(P/N 529 014 700)

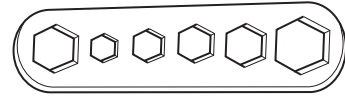

A19B024

#### APPLICATION

All SC 10 suspensions, Safari and Skandic prior to 1995.

Suspension adjustment wrench  
(P/N 529 017 100)

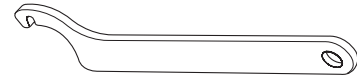

A15B094

#### APPLICATION

1992 and old Formula C-7.

Gas shock valve tool  
(P/N 529 035 570)

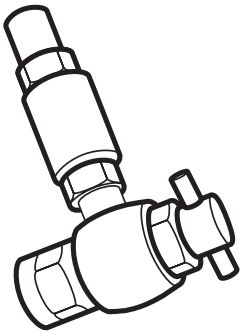

A02F134

#### APPLICATION

T/A shocks.

Drive axle holder  
(P/N 529 007 200)

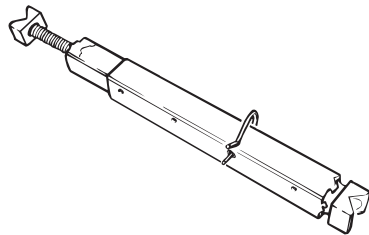

A01B1E4

#### APPLICATION

All models.

Suspension adjustment wrench  
(P/N 529 032 900)



A02F114

#### APPLICATION

ARM suspension.

Drill bit  
(P/N 529 031 800)

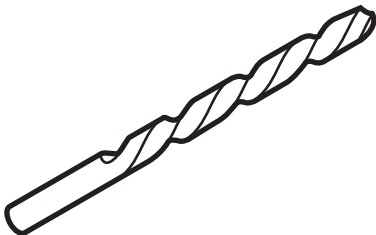

A01B564

#### APPLICATION

All 3/16 inch rivets.

Kayaba shock adjustment tool  
(P/N 529 019 000)

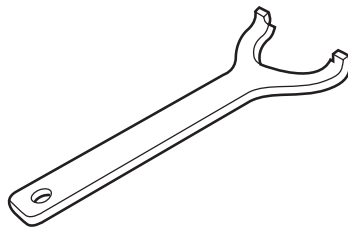

A00A1K4

#### APPLICATION

C-7 suspension.

Suspension adjustment wrench  
(P/N 529 034 100)



A02F124

#### APPLICATION

CK3 series.

**SUSPENSION (continued) — RECOMMENDED SERVICE TOOLS**

Adjustment wrench  
(P/N 861 743 900)

Consists of:

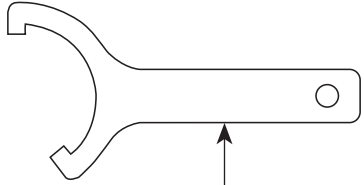

529 024 000

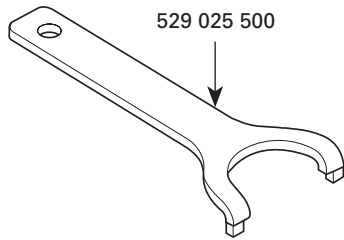

529 025 500

A00B4B4

**APPLICATION**

T/A shock.

## Section 01 SERVICE TOOLS AND SERVICE PRODUCTS

### Subsection 01 (SERVICE TOOLS)

## VEHICLES — RECOMMENDED SERVICE TOOLS

Protective mat  
(P/N 529 030 600)



A01B45W

#### APPLICATION

All vehicles.

Dolly  
(P/N 529 029 900)

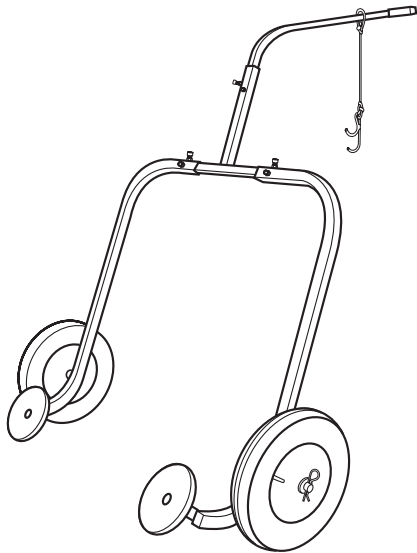

A00B4CJ

#### APPLICATION

All models.

Snowmobile jack  
(P/N 529 020 000)

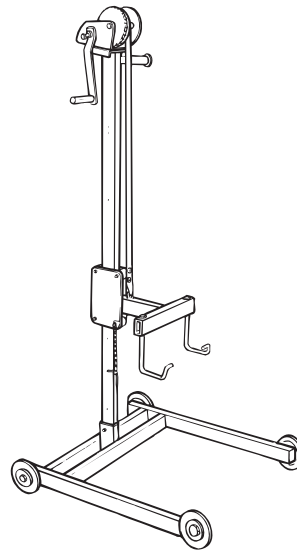

A01A1JJ

#### APPLICATION

All models.

**VEHICLES (continued) — RECOMMENDED SERVICE TOOLS**

Template for hood drilling  
(P/N 529 034 400)

**NEW**



A02H154

**APPLICATION**

S-Series.

**NOTE:** To drill new hood prior to install meters.

Flexible spout for oil container  
(P/N 414 837 300)

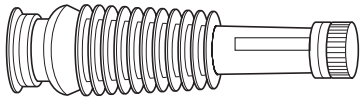

F04B044

**APPLICATION**

All models.

# SERVICE PRODUCTS

## MANDATORY SERVICE PRODUCTS

Loctite® is a trademarks of Loctite Corporation.

Dow Corning® is a trademarks of Dow Corning Corporation.

Retaining compound  
(P/N 413 703 100)  
Loctite® RC/609:  
Retaining compound (10 mL)  
(green)



A00B2S4

### APPLICATION

Used for retaining bushings, bearings in slightly worn housing or on shaft.

Medium-strength threadlocker  
(P/N 293 800 015)  
Loctite® 242:  
Threadlocker (10 mL)  
(blue, medium strength)



A00B324

### APPLICATION

Flywheel nut, crankcase studs, etc.

**NOTE:** Only the P/N has been changed. This product is identical to the P/N 413 703 000.

High strength threadlocker  
(P/N 293 800 005)  
Loctite® 271:  
Threadlocker (10 mL)  
(red, high strength)



A00B2U4

### APPLICATION

Fasteners and studs up to 1 in diameter.

**NOTE:** Only the P/N has been changed. This product is identical to the P/N 413 707 400.

Paste gasket  
(P/N 413 702 700)  
Loctite® 515:  
Gasket eliminator (50 mL)



A00B2T4

### APPLICATION

Crankcase halves, transmission and gearbox mating surfaces.

Gasket/paint remover  
(P/N 413 708 500)  
Loctite® 79040 Chisel  
510 g (18 oz)



A00B3L4

### APPLICATION

Clean mating surfaces of cylinders and crankcase. Remove carbon in combustion chambers.



---

## Section 01 SERVICE TOOLS AND SERVICE PRODUCTS

### Subsection 02 (SERVICE PRODUCTS)

---

#### MANDATORY SERVICE PRODUCTS (continued)

Loctite® primer  
(P/N 293 800 041)  
Loctite® 764-56  
Primer N  
170 g (6 oz)



A00B3N4

#### APPLICATION

To prepare mating surfaces before applying paste gasket, retaining compound or threadlockers.

**NOTE:** Only the P/N has been changed. This product is identical to the P/N 413 708 100.

Silicone compound  
(P/N 420 897 061)  
Dow Corning® MS4



A00B3R4

#### APPLICATION

Lubricate pawl and pawl lock of rewind starter.

**RECOMMENDED SERVICE PRODUCTS**

Silicone dielectric grease  
(3 oz)  
(P/N 293 550 004)

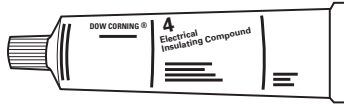

A00B1X4

**APPLICATION**

On all electric connections. High tension coil and spark plug connections. Connector housings, etc.

**NOTE:** Only the P/N has been changed. This product is identical to the P/N 413 701 700.

Grease LMZ no. 1  
(400 g)  
(P/N 413 707 500)



A00B1Y4

**APPLICATION**

Mainly used between regulators or rectifiers and upper column to transfer the heat build-up and to assure a good ground.

Grease Isoflex  
(50 g)  
(P/N 293 550 021)



**APPLICATION**

To lubricate PTO outer bearing on 3-cylinder and 593 engines.

Chaincase oil  
(16 x 250 mL)  
(P/N 413 801 900)



A00B2R4

**APPLICATION**

Chaincase lubricant on all fan-cooled models except Skandic WT series.

Synthetic chaincase oil  
(12 x 355 mL)  
(P/N 413 803 300)



A01B4Q4

**APPLICATION**

Chaincase lubricant on all liquid-cooled models and Skandic WT series.

Blizzard oil  
(12 x 500 mL)  
(P/N 413 803 100)



A00B2Q4

**APPLICATION**

All pre-mix models.

Injection oil  
(P/N 413 802 900)  
(12 x 1 liter)  
(P/N 413 803 000)  
(3 x 4 liter)  
(P/N 413 803 200)  
(205 liters)

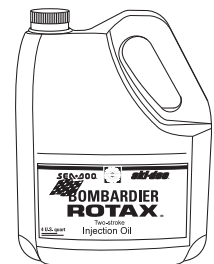

F01B2H4

**APPLICATION**

All engines.

## Section 01 SERVICE TOOLS AND SERVICE PRODUCTS

### Subsection 02 (SERVICE PRODUCTS)

## RECOMMENDED SERVICE PRODUCTS (continued)

BOMBARDIER-ROTAX Formula  
XP-S synthetic injection oil  
(P/N 413 711 000)  
(3 x 4 liter)  
(P/N 413 710 700)  
(205 liters)



F01B354

#### APPLICATION

All engines.

High temperature threadlocker  
(P/N 420 899 788)  
Loctite 648 (green)  
(5 g)



A00B3D4

#### APPLICATION

For RAVE valve rod distance nut.

Synthetic grease  
(400 g)  
(P/N 413 711 500)



A01B574

#### APPLICATION

For idler bearings, ski legs, leaf spring cushion pads, seal interior lips, rear hub bearings, bogie wheels, countershaft bearings, etc.

BOMBARDIER-ROTAX Formula  
XP-S synthetic injection oil  
(P/N 413 710 500)  
(12 x 1 liter)



F01B2G4

#### APPLICATION

All models.

Anti-seize lubricant  
(P/N 413 701 000)  
Loctite anti-seize  
lubricant 454 g (16 oz)



F01B174

#### APPLICATION

Unpainted surfaces of driven pulley countershaft.

Storage oil  
(350 g spray can)  
(12 x 350 g)  
(P/N 496 014 100)



A02B054

#### APPLICATION

All models.

Pipe sealant  
(P/N 413 702 300)  
Loctite 592 (50 mL)



A00B2W4

#### APPLICATION

Engine plugs and senders.

## Section 01 SERVICE TOOLS AND SERVICE PRODUCTS

### Subsection 02 (SERVICE PRODUCTS)

## RECOMMENDED SERVICE PRODUCTS (continued)

Degreaser  
(P/N 413 708 400)  
Permatex® 48 TA  
433 g (15 oz)



A00B3K4

#### APPLICATION

Engine, chaincase and any greasy surfaces.

Parts cleaner  
(P/N 413 711 809)  
320 g



A00B4X4

#### APPLICATION

Engine crankcase joining surfaces, pulleys and any greasy surfaces.

**NOTE:** This product replaces Loctite Safety solvent (P/N 413 708 200).

Tough adhesive  
(P/N 413 408 300)  
Loctite Black Max 38004  
3 mL (.10 oz)



A00B3P4

#### APPLICATION

Shifter boot or grip.

Plastic & vinyl cleaner  
(P/N 413 711 200)  
6 x 1 L



A00B4V4

#### APPLICATION

Hood, bottom pan and seat.

Stripped threads repair kit  
(P/N 413 708 600)  
Loctite 81668  
Form-A-thread 81668

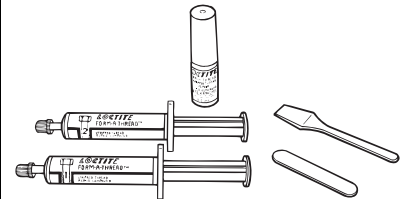

A00A1J4

#### APPLICATION

Repair damaged threads of grade 5 (SAE) or 8.8 (metric) maximum. Do not use in applications where temperatures will exceed 149°C (300°F) or on critical assemblies.

Gel instant adhesive  
(P/N 413 708 300)  
Loctite 454-40  
20 g (.70 oz)



A00B3O4

#### APPLICATION

Isolating foam and rubber strip.

Paint for frame touch-up  
(P/N 413 401 000)  
Black semi-gloss  
(spray can)

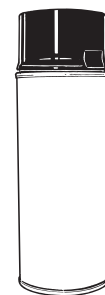

A00B3H4

#### APPLICATION

All models with a black frame.

## Section 01 SERVICE TOOLS AND SERVICE PRODUCTS

### Subsection 02 (SERVICE PRODUCTS)

## RECOMMENDED SERVICE PRODUCTS (continued)

General purpose instant adhesive  
Loctite 495 (3 g)  
(P/N 413 703 200)

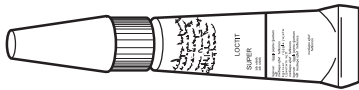

A00B2V4

#### APPLICATION

Rubber to metal bonding and most hard plastic.

Bombardier cleaner  
(P/N 293 110 001) (400 g)  
(P/N 293 110 002) (4 L)



F01B2J4

#### APPLICATION

All models.

Molykote 111  
(P/N 413 707 000)

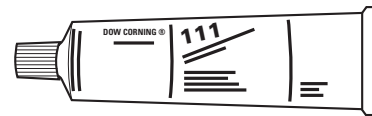

A00B3W4

#### APPLICATION

Engine crankshaft seals.

High temperature RTV sealant  
Ultra Copper  
(P/N 413 710 300)  
Loctite 17914 (80 mL)



A02B044

#### APPLICATION

All models.

Clear silicone  
(P/N 293 800 033)



F01B1S4

#### APPLICATION

All models to seal bottom pan.

Shock oil  
(32 oz)  
(P/N 413 709 400)



A06F0P4

#### APPLICATION

T/A shocks.

Fuel stabilizer  
(12 x 8 oz)  
(P/N 413 408 600)



A00B3V4

#### APPLICATION

All models.

Bombardier Lube  
(12 x 14 oz)  
(P/N 293 600 016)



A00B4W4

#### APPLICATION

Steering ball joints on all models.

**Section 01 SERVICE TOOLS AND SERVICE PRODUCTS**

Subsection 02 (SERVICE PRODUCTS)

**RECOMMENDED SERVICE PRODUCTS (continued)**

Super Lube (grease)  
(P/N 293 550 014)



A00B474

**APPLICATION**

Exhaust tail pipe grommet.