

# **ski-doo**®

1997  
**SHOP MANUAL**



**GRAND  
TOURING SE**

**SUPPLEMENT**

4 8 4 0 6 4 7 0 4



***ski-doo***®

**1997**  
***Shop Manual Supplement***

GRAND TOURING SE





Legal deposit:

National Library of Quebec  
4<sup>th</sup> trimester 1996  
National Library of Canada 1996

All rights reserved. No parts of this manual may be reproduced in any form without the prior written permission of Bombardier Inc.

©Bombardier Inc. 1996

Technical Publications  
Bombardier Inc.  
Valcourt (Quebec) Canada

Printed in Canada

®\*Registered trademarks of Bombardier Inc.

# TABLE OF CONTENTS

SECTION		PAGE
	SAFETY NOTICE .....	V
	INTRODUCTION AND ..... ABBREVIATION LIST	VI
	LUBRICATION AND MAINTENANCE .....	*
<b>01</b>	TOOLS .....	01-1
<b>02</b>	TROUBLESHOOTING .....	02-1
	ENGINE	
	Table of contents.....	*
	699 Engine .....	*
	Leak test and engine dimension measurement .....	*
	CDI system (360-watt magneto system).....	03-1
	Oil injection system.....	*
	Liquid cooling system.....	*
	Rewind starter .....	*
	Carburetor and fuel pump.....	05-1
	Fuel tank and throttle cable .....	*
	TRANSMISSION	
	Table of contents.....	*
	Drive belt .....	*
	Drive pulley .....	*
	Driven pulley.....	*
	Pulley distance and alignment.....	*
	Brake .....	*
	Gearbox .....	**
	Drive chain.....	*
<b>03</b>	ELECTRICAL SYSTEM	
	Table of contents.....	*
	Wiring diagrams.....	08-1
	Ignition timing.....	*
	Spark plugs .....	*
	360-watt magneto system .....	03-1
	Component location .....	03-1
	Theory and operation.....	03-1
	Testing procedure .....	03-2
	Heating elements switches system .....	03-3
	Component location .....	03-3
	Theory and operation.....	03-3
	Testing procedure .....	03-3
	Dimmer switch system .....	03-4
	Component location .....	03-4
	Theory and operation.....	03-4
	Testing procedure .....	03-4

\* Refer to *1997 Shop Manual volume 3* (P/N 484 0647 02)

\*\* Refer to *1997 Shop Manual volume 2* (P/N 484 0647 01)



# TABLE OF CONTENTS

SECTION		PAGE	
<b>04</b>	DESS SYSTEM	Component location.....	04-1
		Theory and operation.....	04-1
		Testing procedure.....	04-2
<b>05</b>	DIGITAL PERFORMANCE MANAGEMENT (DPM) SYSTEM	Component location.....	05-1
		Theory and operation.....	05-1
		Testing procedure.....	05-10
<b>06</b>	AIR SUSPENSION SYSTEM	Table of contents.....	*
		SC-10 Suspension (Touring).....	**
		Drive axle.....	*
		Track.....	*
		Component location.....	06-1
		Theory and operation.....	06-1
		Testing procedure.....	06-1
STEERING/ FRONT SUSPENSION	Table of contents.....	*	
	Steering system.....	*	
	Suspension and ski system.....	*	
BODY/FRAME	Table of contents.....	*	
	Body.....	*	
	Frame.....	*	
<b>07</b>	TECHNICAL DATA	Engine.....	07-1
		Vehicle.....	07-2
		Technical data legends.....	07-3
<b>08</b>	WIRING DIAGRAM	.....	08-1

\* Refer to *1997 Shop Manual volume 3* (P/N 484 0647 02)

\*\* Refer to *1997 Shop Manual volume 2* (P/N 484 0647 01)

### SAFETY NOTICE

This manual has been prepared as a guide to correctly service and repair the 1997 Ski-Doo Grand Touring SE. See model list on next page.

This edition was primarily published to be used by snowmobile mechanics who are already familiar with all service procedures relating to Bombardier made snowmobiles.

Please note that the instructions will apply only if proper hand tools and special service tools are used.

This *Shop Manual Supplement* uses technical terms which may be slightly different from the ones used in *Parts Catalog*.

The content depicts parts and/or procedures applicable to the particular product at its time of manufacture. It does not include dealer modifications, whether authorized or not by Bombardier, after manufacturing the product.

In addition, the sole purpose of the illustrations throughout the manual, is to assist identification of the general configuration of the parts. They are not to be interpreted as technical drawings or exact replicas of the parts.

The use of Bombardier parts is most strongly recommended when considering replacement of any component. Dealer and/or distributor assistance should be sought in case of doubt.

The engines and the corresponding components identified in this document should not be utilized on product(s) other than those mentioned in this document.

Torque wrench tightening specifications must be strictly adhered to. Locking devices (ex.: locking tab, elastic stop nut, etc.) must be installed or replaced with new ones, when damaged. If the efficiency of a locking device is impaired, it must be renewed.

This manual emphasizes particular information denoted by the wording and symbols;

 <b>WARNING</b>
--

Identifies an instruction which, if not followed, could cause serious personal injury including possibility of death.
---

 <b>CAUTION</b>
--

Denotes an instruction which, if not followed, could severely damage vehicle components.
--

**NOTE:** Indicates supplementary information needed to fully complete an instruction.

Although the mere reading of such information does not eliminate the hazard, your understanding of the information will promote its correct use. Always use common shop safety practice.

This information relates to the preparation and use of Bombardier snowmobiles and has been utilized safely and effectively by Bombardier Inc. However, Bombardier Inc. disclaims liability for all damages and/or injuries resulting from the improper use of the contents. We strongly recommend that any services be carried out and/or verified by a highly skilled professional mechanic. It is understood that certain modifications may render use of the vehicle illegal under existing federal, provincial and state regulations.

# 1997 GRAND TOURING SE SHOP MANUAL SUPPLEMENT

## INTRODUCTION

The 1997 Grand Touring SE comprises 6 new systems. The *1997 Shop Manual Supplement* describes how these systems operate as well as the procedures to test them.

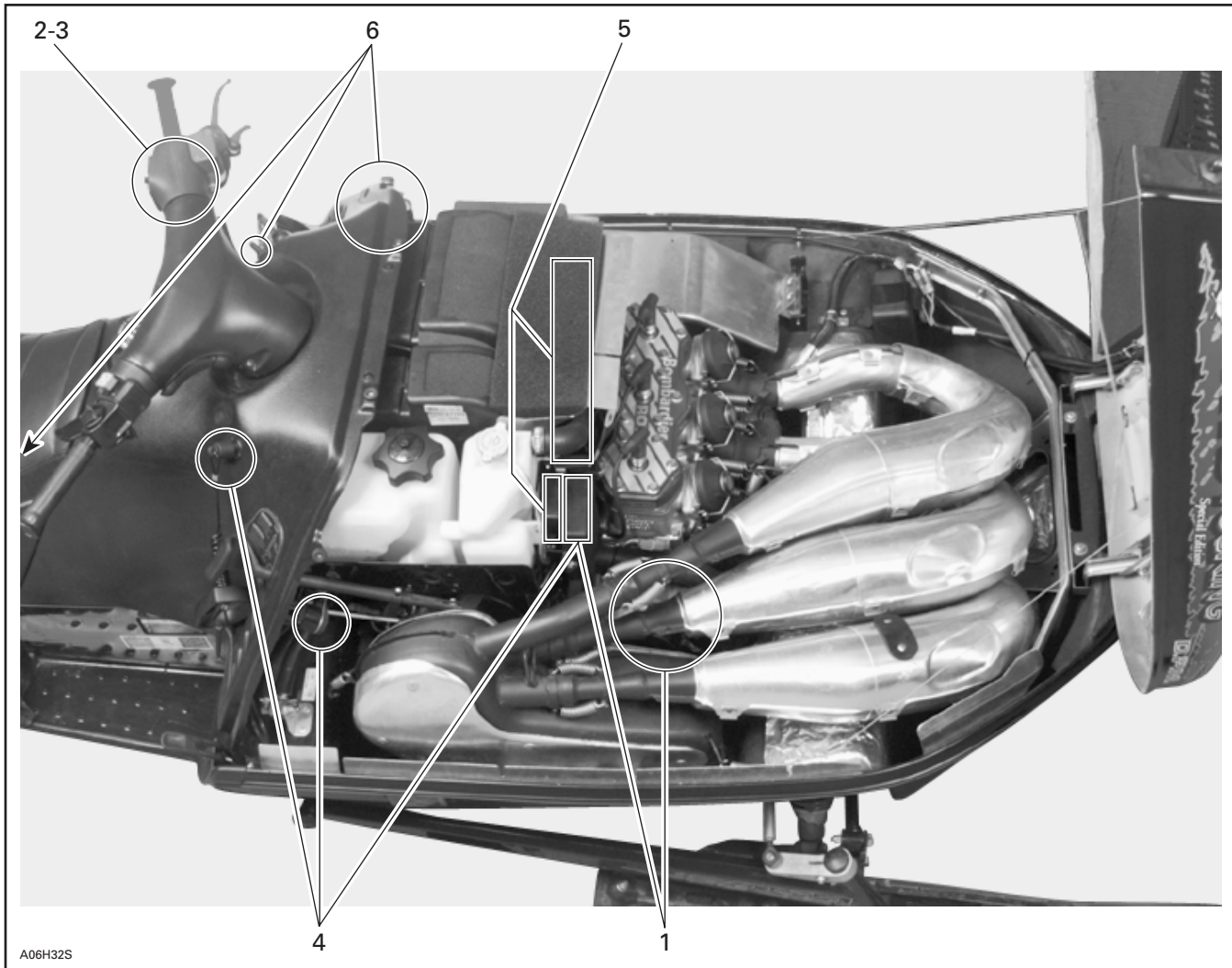

A06H32S

1. Magneto system
2. Heating elements switches system
3. Headlamp dimmer switch system
4. DESS
5. Digital performance management system (DPM)
6. Air suspension

Troubleshooting tables (by system) can be found in section 02 of this supplement.

# 1997 GRAND TOURING SE SHOP MANUAL SUPPLEMENT

## ABBREVIATION LIST

CDI	Capacitor Discharge Ignition
DESS	Digitally Encoded Security System
DPM	Digital Performance Management
Hz	Hertz (1 cycle per second)
PSI	Pound per Square Inch
MAG	Magneto ( magneto side)
mbar	millibar
MPEM	Multi-Purpose Electronic Module
PTO	Power Take Off (drive pulley side)
ROM	Read Only Memory
RPM	Revolutions Per Minute
VDC	Volt Direct Current

MODELS	MODEL NUMBER
GRAND TOURING SE (CANADA) .....	1129
GRAND TOURING SE (U.S.).....	1130
GRAND TOURING SE (EUROPE) .....	1131

Each Vehicle has its Particular Vehicle  
Serial Number

Serial Number Meaning

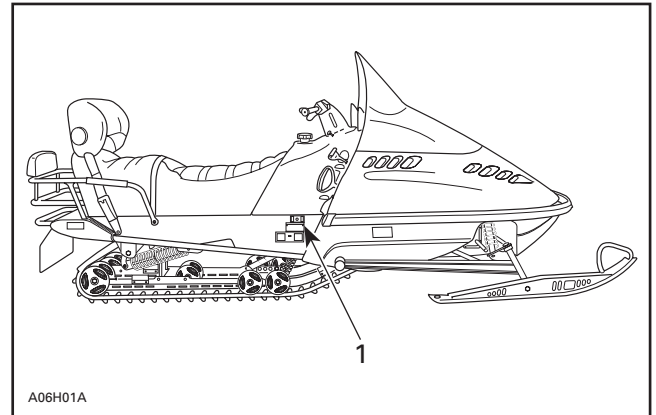
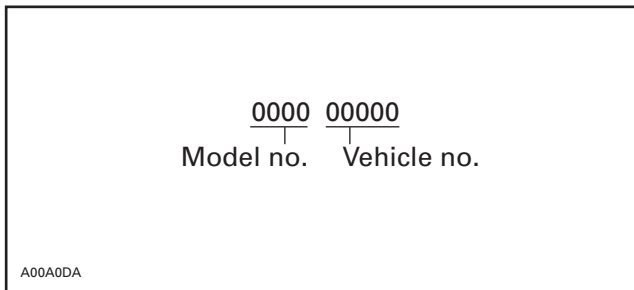

TYPICAL

1. Vehicle serial number

The engine also has a serial number.

### Liquid-Cooled Engines

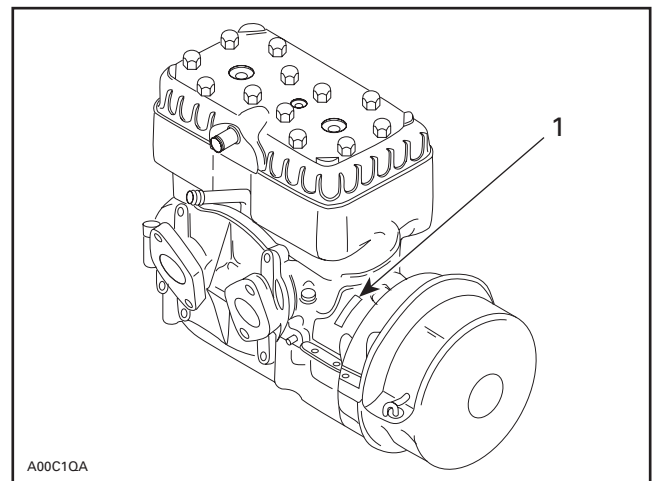

1. Engine serial number

## ▼ CAUTION

Most components of those vehicles are built with parts dimensioned in the metric system. Most fasteners are metric and must not be replaced by customary fasteners or vice versa. Mismatched or incorrect fasteners could cause damage to the vehicle or possible personal injury.

# TOOLS



A00B4HA

TYPICAL — ADAPTOR (P/N 529 0338 00)

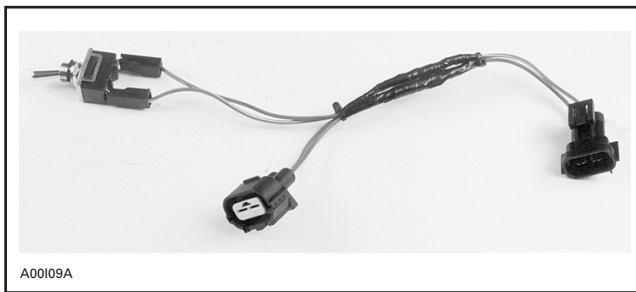

A00I09A

BYPASS WIRES (P/N 529 0333 00)

These wires ensure continuity between the battery and loads without the engine running. All accessories are ON except for the buzzer.

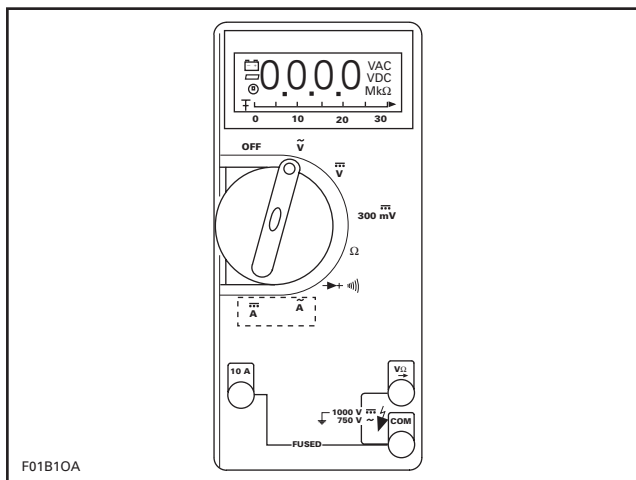

F01B10A

FLUKE MULTIMETER (P/N 529 0220 00)

# TROUBLESHOOTING

## ELECTRICAL SYSTEM

Always start by checking the fuse.

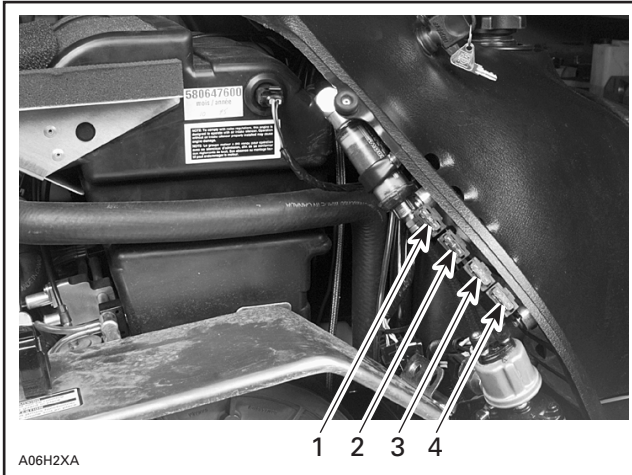

1. Main including starter 30 A
2. Digital performance management 1 A
3. Compressor 20 A
4. All others except starter 20 A

## DESS SYSTEM (DIGITAL ENCODED SECURITY SYSTEM)

Always start by checking the fuse.

## DIGITAL PERFORMANCE MANAGEMENT (DPM) SYSTEM

Always start by checking the fuse.

If the DPM seems to be defective, unplug fuse 1A while the engine is running. The carburation is now identical to that of carburetors without a DPM provided, of course, that all pipe fittings are tight and that solenoids are in good condition. None must be half-open.

## AIR SUSPENSION SYSTEM

Always start by checking the fuse.

# ELECTRICAL SYSTEM

## 360-WATT MAGNETO SYSTEM

### COMPONENT LOCATION

Refer to photos included with the electrical diagram.

### THEORY AND OPERATION

#### Charging System

#### Lighting Coil

This 360-watt coil produces alternating current.

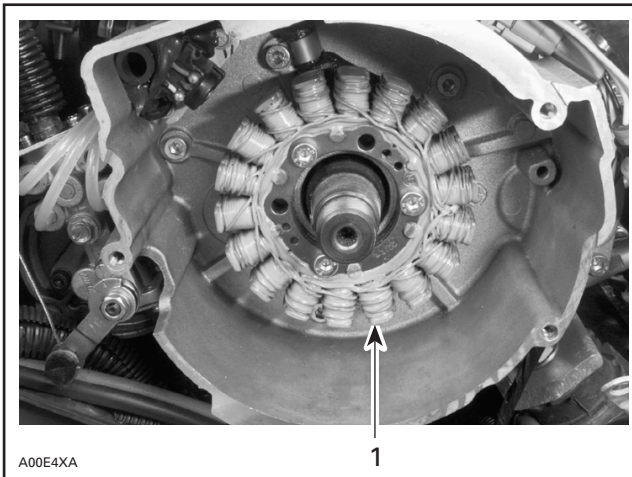

**360-WATT MAGNETO**

1. Triple coil (3-phase)

#### Regulator/Rectifier

First, the regulator/rectifier converts the alternating current of the magneto into direct current (DC).

It uses diode bridges allowing the alternating current to pass in one direction only.

The negative (-) wire (black) is connected to ground (regulator housing) and to the frame, while the positive wire is RED/BLUE.

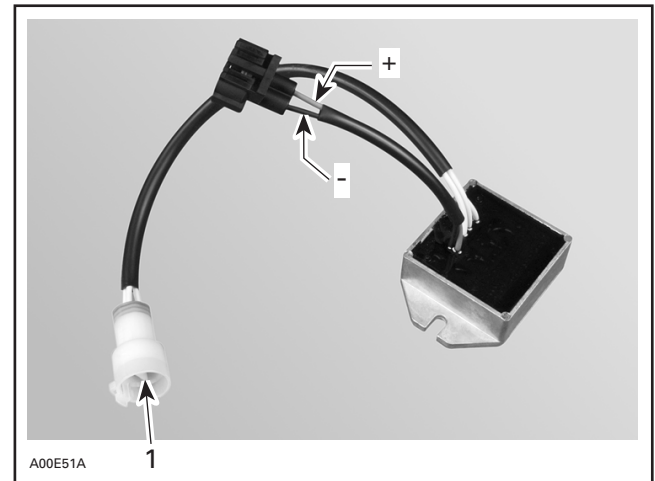

+ Positive  
- Negative  
1. Magneto

All accessories are fed with direct current.

**NOTE:** The tachometer receives a very small portion of the alternating current through the WHITE/GREEN wire. The tachometer must detect a variable pulse (alternating current) to operate. Note that it is the only accessory fed with alternating current but operating on direct current.

After rectifying the magneto current, the regulator/rectifier limits the magneto voltage to 14.7 volts.

**NOTE:** In simpler terms, an electrical system producing 14.7 volts is called a 12-volt system.



## Section 03 ELECTRICAL SYSTEM

### Ignition System — MPEM Module (Multi-Purpose Electronic Module)

This module operates on direct current (12 VDC).

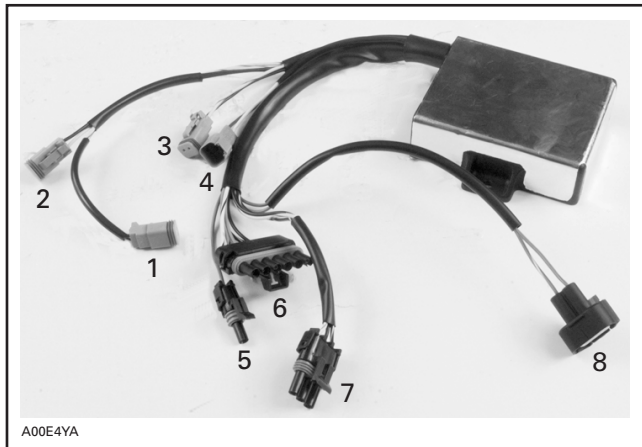

#### MPEM

1. PTO high tension coil; 3-05 housing
2. CENTRE high tension coil; 3-04 housing
3. MAG high tension coil; 3-03 housing
4. Trigger coil; 2-03 housing
5. Positive supply; 2-03 housing
6. Ground, buzzer, warning light, signal to DPM, engine shut-off; 3-06 housing
7. DESS switch
8. Load breaker

The 360-watt magneto has no ignition generator coil. All the ignition current comes from the magneto coil. A BLACK/YELLOW wire allows the engine to stop. Grounding this wire will short-circuit the ignition module.

Trigger coil pulses are sent to the module in order to ignite the spark plug at the right time.

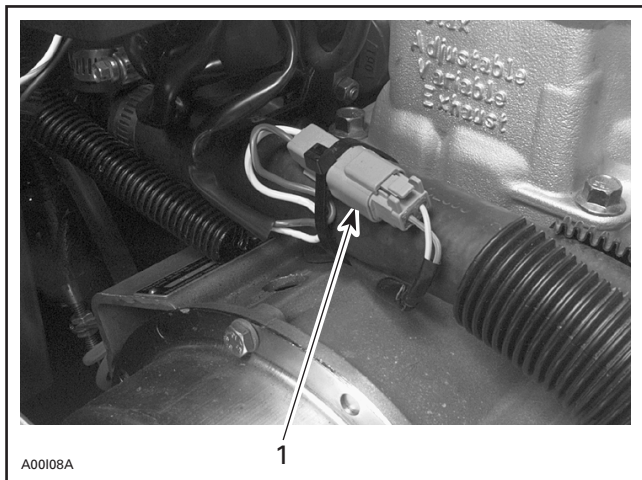

1. Trigger coil wires; 2-03 housing

This device includes the DESS system. See section 3.

This module also activates the warning buzzer (reverse and DESS code).

Finally, the MPEM controls load supply (headlamp, taillight, dashboard gauges, heated components, etc.). If the key is left in the ON position without the engine running, the MPEM will not supply current to the loads, and this to prevent discharging of the battery. The MPEM will only allow the loads to be fed (20A fuse, through RED/YELLOW wire) if the engine revolution exceeds 800 RPM.

## TESTING PROCEDURE

### Magneto

#### Coil Testing

**NOTE:** The coil being triple, all 3 parts must be tested separately. Refer to the electrical diagram at the end of this supplement.

Connect an ohmmeter to the magneto YELLOW/YELLOW wires (2-04A, 2-04B and 2-04C).



The resistance must be as indicated in the following table. All 3 sections of the coil have the same resistance.

WIRES	RESISTANCE VALUES $\Omega$
YELLOW and YELLOW	maximum 0.5

#### Coil Insulation Test

Disconnect 2-01 housing.

**NOTE:** Disconnect WHITE/GREEN wire (2-01-2) before testing coil insulation. Otherwise, the magneto coil remains connected to the tachometer and the reading will be false.

Disconnect 2-04 magneto outlet.



Connect an ohmmeter probe to ground and the other probe to each of the yellow wires.

There must be no continuity.

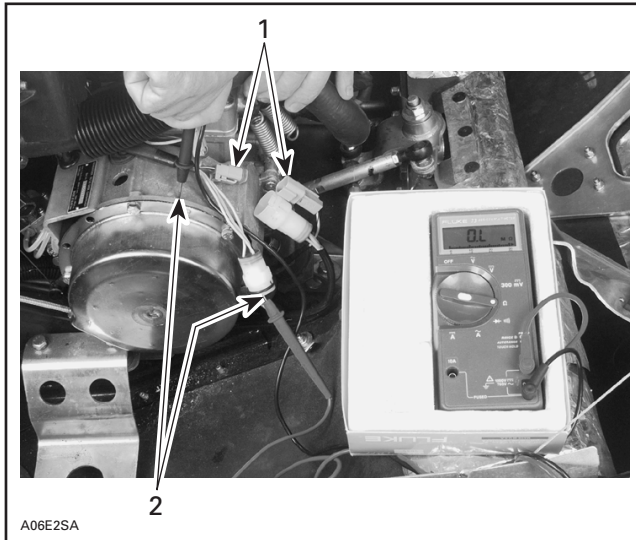

1. 2-01 housing disconnected  
2. Ohmmeter probes

### Voltage Regulator

The battery must be at room temperature. Connect a DC voltmeter to the battery. Note voltage. If the battery is charged, the voltmeter shall indicate  $12.5 \pm 0.3$  VDC.

Start the engine. The voltage must increase depending on engine speed.

## HEATING ELEMENTS SWITCHES SYSTEM

### COMPONENT LOCATION

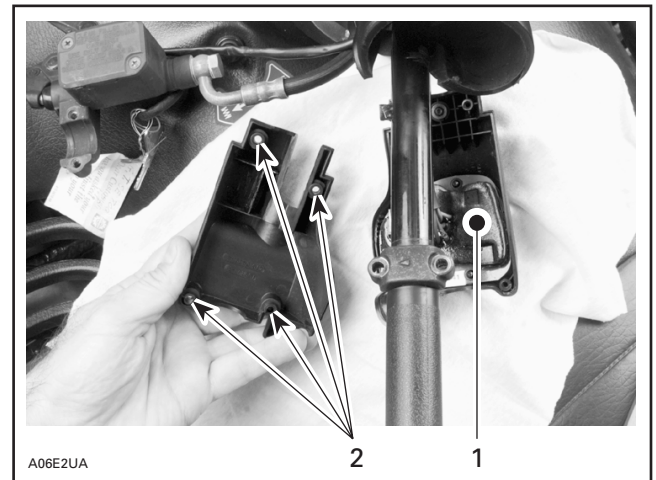

1. Intensity control module  
2. Screw location

## THEORY AND OPERATION

### Heating Elements Switches

These toggle switches allow selecting 5 different heating levels from the heating elements (heated grips and heated throttle).

Each time the engine is started, the lowest heating intensity is selected.

Press switch at the desired position. Clicking + to increases heating and clicking - decreases it.

When holding switch for more than about 1 second will increase to maximum intensity or OFF position according selected position.

### Intensity Control Module

This module controls the current returning from heating elements. This module also controls the dimmer switch.

## TESTING PROCEDURE

### Intensity Control Module

If indicator lights are on, the module works. This module cannot be repaired. It must be replaced when defective.

#### Removal

Remove brake master cylinder. See previous photo.

Unscrew the 4 screws holding the module to the handlebar.

## Section 03 ELECTRICAL SYSTEM

### Heating Elements

Measure element resistance.

ELEMENTS	WIRES	RESISTANCE $\Omega$
Handle (only one)	Wires of only one handle	$9.7 \pm 1$
2 handles	YELLOW/BLACK and ORANGE (6-09A and 6-09D)	$4.8 \pm 1$
Accelerator	YELLOW/BLACK and BROWN (6-09B and 6-09C)	$72 \pm 10$

### THEORY AND OPERATION

#### Dimmer Switch

The dimmer switch allows selection of headlamp beam.

**NOTE:** When holding switch for more than 1 second to dim light (from high to low beam), light will return to high beam position automatically after 10 seconds.

#### Intensity Control Module

This module controls the headlamp circuit ground.

### TESTING PROCEDURE

This module cannot be repaired. Replace it when defective.

#### Removal

Remove brake master cylinder. See previous photo.

Unscrew the 4 screws holding the module to the handlebar.

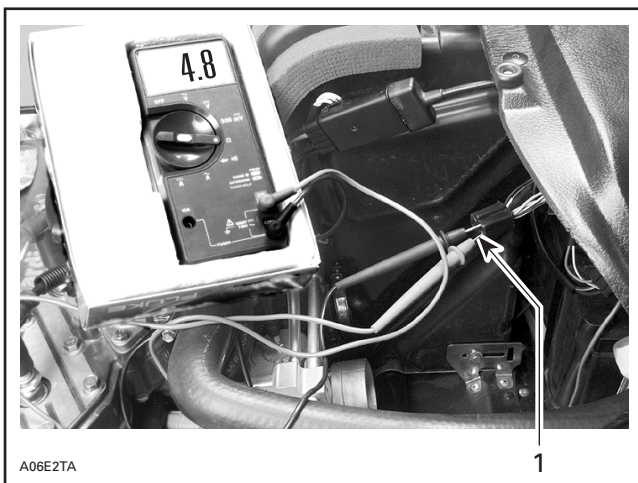

1. Probes to YL/BK and to OR wires (element side); 6-09 housing

### DIMMER SWITCH SYSTEM

#### COMPONENT LOCATION

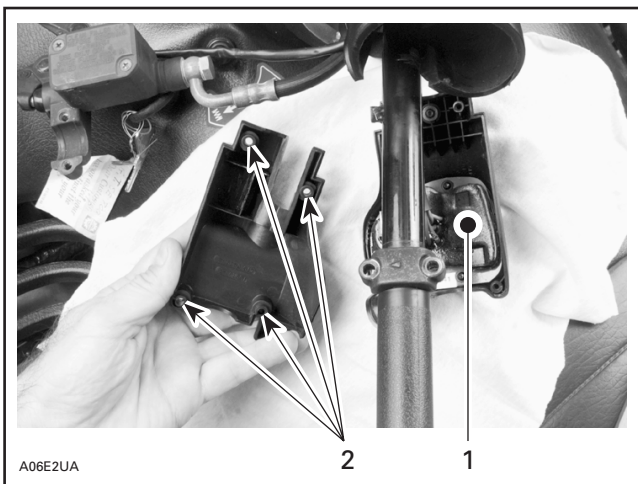

1. Intensity control module  
2. Screw location

# DESS SYSTEM (Digitally Encoded Security System)

## COMPONENT LOCATION

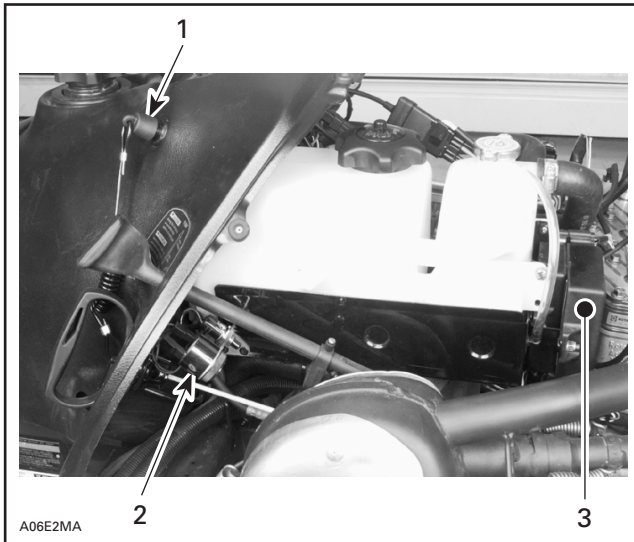

1. Safety lanyard switch and cap
2. Buzzer
3. MPEM

## THEORY AND OPERATION

This system is a deterrent against theft. Dealer programmed, the tether cord provided with the snowmobile is the only one that allows engine to turn more than 2500 RPM. If a wrong tether cord is installed the engine can not reach engagement speed required to move vehicle.

The snowmobile micro-processor (MPEM) can be programmed to allow the use up to 8 tether cords.

After engine is started 2 beeps confirm that the micro-processor has recognized the tether cord. The vehicle can be normally driven.

A beep per 3 seconds and DESS pilot lamp blinking as same rate mean that a bad connection has been detected. Vehicle can not be driven.

To check for bad connection, remove tether cord make sure it is free of dirt or snow. Reinstall tether cord and restart engine. If a beep per 3 seconds still occurs verify tether cord switch.

A continuous beep and DESS pilot lamp blinking rapidly mean that a wrong tether cord is installed. Vehicle can not be driven.

Check that you have both good vehicle and tether cord.

## Multi-Purpose Electronic Module (MPEM)

**NOTE:** The module must be programmed in order to accept a tether cord.

This module cuts off the ignition at 2500 RPM in antitheft mode (wrong tether cord) or in case of a bad connection.

The module activates the indicator light and the alarm (depending on the antitheft mode).

It also activates the back-up alarm when required.

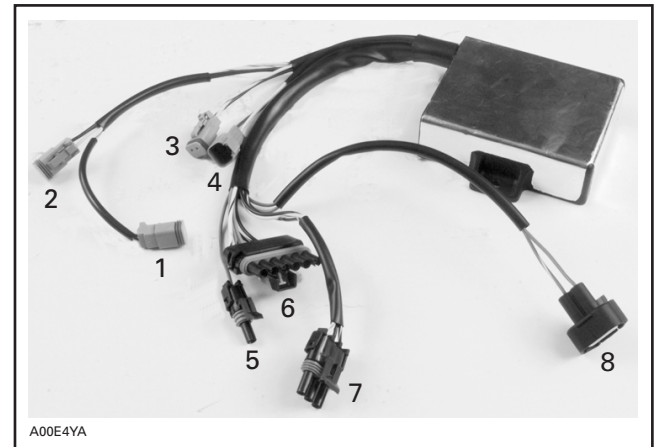

### MPEM

1. PTO high-tension coil; 3-05 housing
2. CENTER high-tension coil; 3-04 housing
3. MAG high-tension coil; 3-03 housing
4. Trigger coil; 2-03 housing
5. Positive supply; 2-03 housing
6. Ground, warning device, indicator light, DPM signal, engine shut-off; 3-06 housing
7. DESS switch
8. Load breaker

## DESS Indicator Light

This indicator light comes on when the DESS system is activated.

The indicator light blinks at the rate of once every 3 seconds to indicate a bad connection of the tether cord.

The indicator light blinks rapidly to indicate a wrong tether cord.

## Section 04 DESS SYSTEM

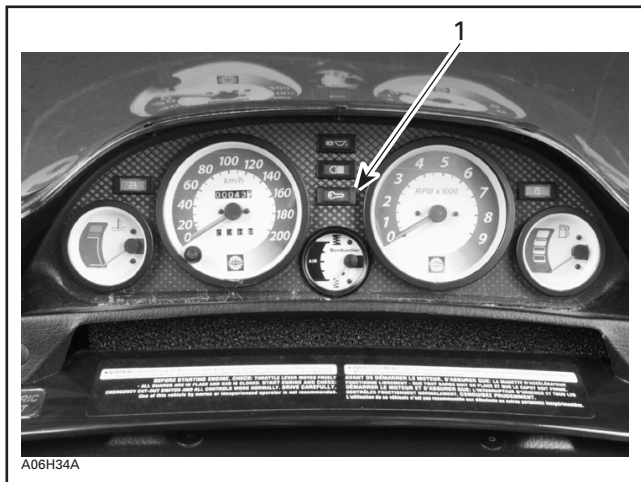

1. DESS indicator light

### Buzzer

This buzzer comes on to indicate the DESS status. The buzzer is heard twice to indicate that the proper tether cord has been connected. The engine can then be operated at full RPM.

The buzzer is heard once every 3 seconds to indicate a bad connection of the tether cord, and therefore, the engine revolution cannot exceed 2500 RPM.

The buzzer is heard continuously when connecting a wrong tether cord. It is then impossible to operate the engine at more than 2500 RPM.

When backing up, the buzzer is heard once every second.

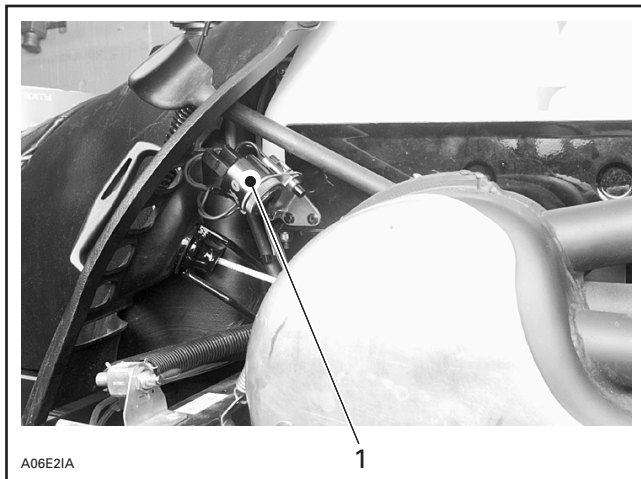

1. Buzzer

## TESTING PROCEDURE

### Buzzer

Unplug buzzer wires. Plug a battery in good operating condition to buzzer connectors. Observe polarity (the + and - signs are printed on the buzzer).

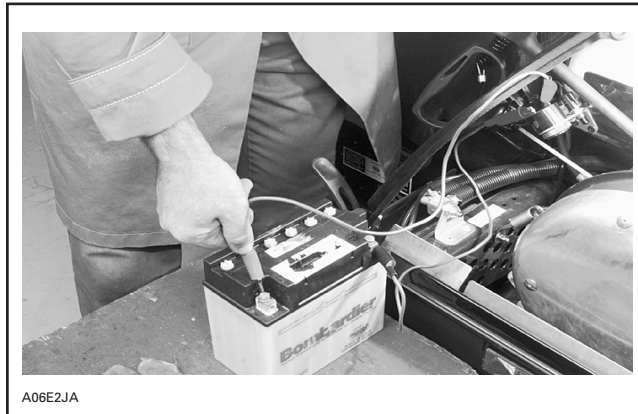

Replace the buzzer if it remains silent.

### Buzzer Supply

With the engine running, connect a jumper between ground and buzzer negative connector. The buzzer should then be heard. If not, check positive supply as follows. Plug the positive probe of a voltmeter to the buzzer RED/YELLOW wire (4-02) and the negative sensor to ground. The voltage must be the same as that of the battery. If not, check RED/YELLOW wire continuity.

If the positive supply is good, check BEIGE/BLACK wire leading to the MPEM. If this wire is good, replace MPEM and recheck.

### Tether Cord Switch

#### Switch Continuity Check

Connect an ohmmeter to BLACK/GREEN (6-01B) and BLACK/WHITE wires (6-01C). Install a tether cord in good operating condition previously checked with programmer. Resistance must be equal to zero (0).





1. 6-01 housing

**Switch Wire Continuity Check**

Check continuity (null resistance) between switch center terminal and WHITE/GRAY wire (6-01A).

Check continuity (null resistance) between switch side ring and BLACK/GREEN wire connector (6-01B).

# DIGITAL PERFORMANCE MANAGEMENT (DPM) SYSTEM

## COMPONENT LOCATION

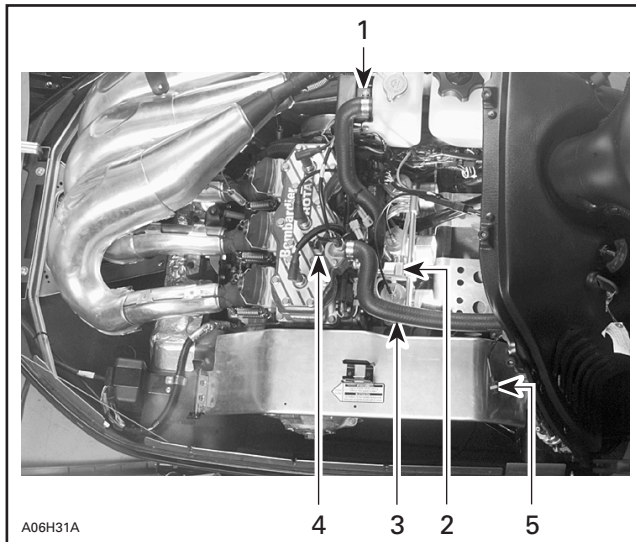

1. *DPM module*
2. *Manifold*
3. *Pump*
4. *Engine temperature sensor*
5. *Air temperature sensor*

## THEORY AND OPERATION

### PURPOSE

Calibrate the air/fuel mixture in order to optimize the engine output while reducing fuel consumption.

### METHOD

The system makes the pressure vary within the carburetor bowl.

## Section 05 DIGITAL PERFORMANCE MANAGEMENT (DPM) SYSTEM

### OVERALL SYSTEM OPERATION

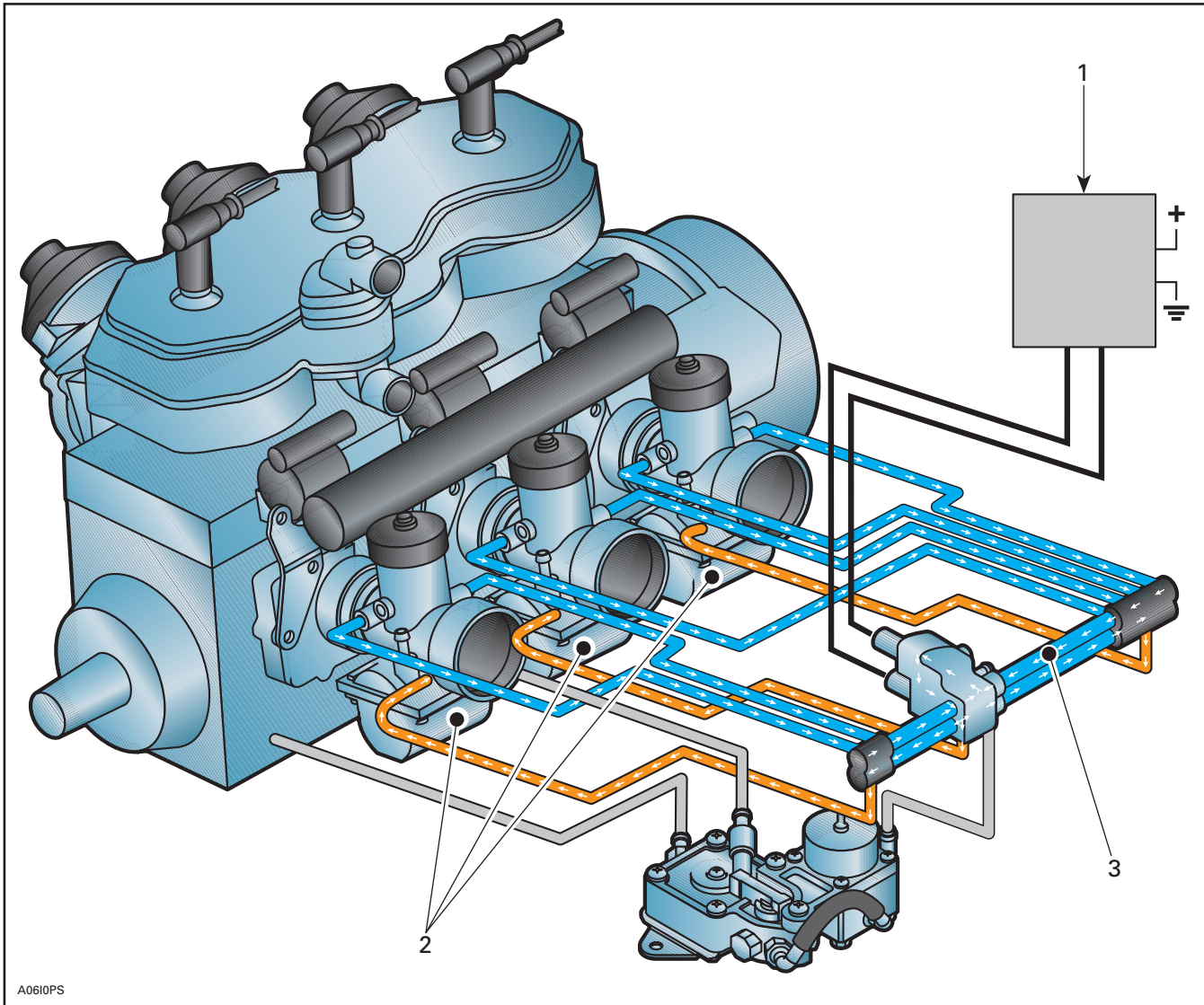

1. DPM module
2. Carburetor bowls
3. Distribution gallery (upper tube)

### Introduction

The engine is being started using the electrical or the manual starter.

The DPM module increases pressure within all 3 carburetor bowls thus the air/fuel mixture is enriched. This is what we call the enrichment mode.

As soon as the spark plug gives off its first spark, the DPM module calculates the enrichment time and rate based on the engine temperature.

Approximately one minute after starting the engine, the module goes from enrichment to standby mode.

Carburetor bowls then receive the atmospheric pressure, and the air/fuel mixture is identical to that of carburetors without the digital performance management (DPM) system.

If engine speed is increased to approximately 3000 RPM, the module goes from standby to compensation mode. The air temperature must exceed  $-20^{\circ}\text{C}$  ( $-4^{\circ}\text{F}$ ) and the air pressure must be lower than 1000 mbar.

Float bowls are now under vacuum and the air/fuel mixture is leaner.

**NOTE:** Both modes can never operate at the same time. The system either makes the mixture richer or leaner. Or, the mixture remains unchanged when module is on standby.

### DPM MODULE OPERATION

#### General

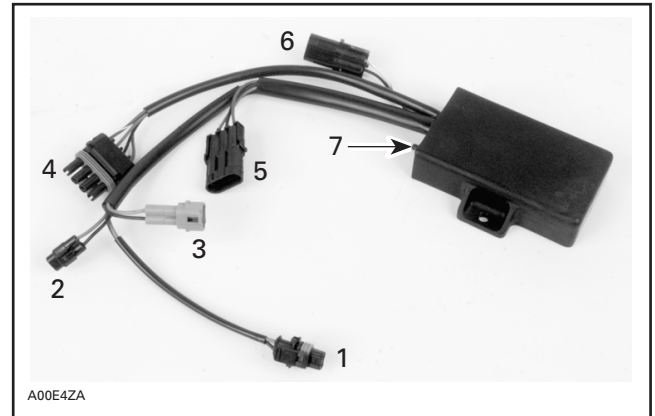

1. Engine temperature sensor, 3-09 housing
2. Enrichment solenoid, 3-11 housing
3. Compensation solenoid, 3-10 housing
4. Power supply (+ and -), signal for MP&EM, air temperature sensor, 3-07 housing
5. Enrichment switch, 3-08 housing
6. Communication port (reserved to manufacturer), 2-05 housing
7. Atmospheric pressure nipple

Direct current is supplied to the module which is protected with a 1 A fuse.

BLACK and WHITE/GRAY wires (2-05 housing) are used for programming by the manufacturer. Nothing must be plugged to this housing.



## Section 05 DIGITAL PERFORMANCE MANAGEMENT (DPM) SYSTEM

### Enrichment Mode (starting)

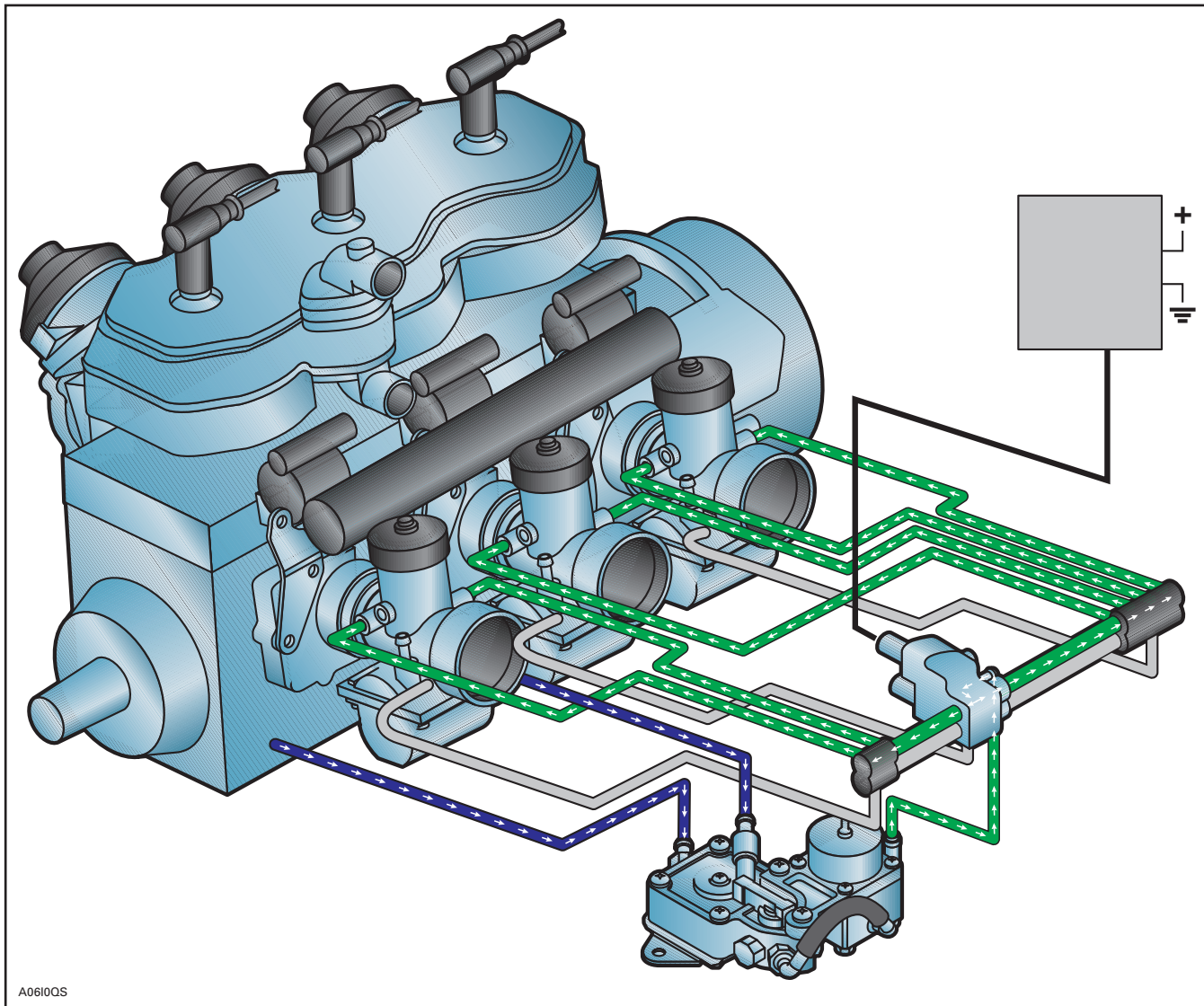

When turning the ignition key to the ON position, the module is energized and goes on standby. The module uses no electricity when on standby.

Once the engine begins to turn (using either the electrical or rewind starter), the module receives pulses through the MPEM (multi-purpose electronic module) ignition system GRAY/GREEN wire.

The DPM module then comes on by reading the engine temperature through the sensor located on the cylinder head. The DPM module calculates the enrichment solenoid opening time and the enrichment rate according to the temperature. The air/fuel mixture is then enriched in order to facilitate starting.

The system pressurizes all 3 carburetor bowls in order to enrich the air/fuel mixture. This is accomplished with the help of an air pump.

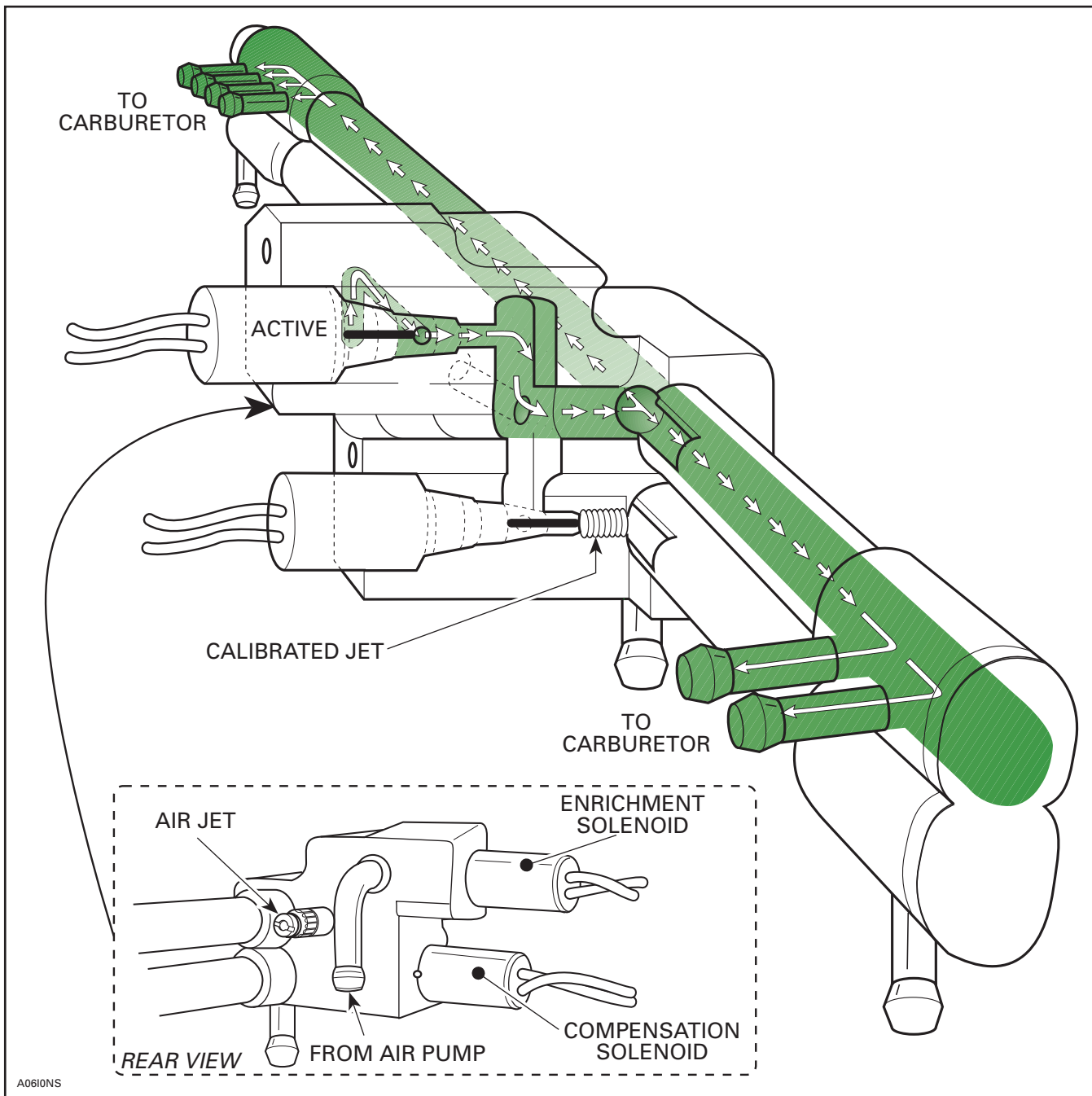

This enrichment process of the air/fuel mixture takes place at start-up and during engine warm-up, and it depends on engine temperature.

The higher the engine temperature upon start-up, the leaner the mixture.

This enrichment progressively decreases and takes place during no more than approximately 1-1/2 minutes. Once the engine is started, the module reduces the solenoid duty cycle. The warmer the engine, the shorter the enrichment mode.

If the throttle opening exceeds one quarter, the enrichment mode is interrupted during the starting process, which allows unflooding the engine.

However, the enrichment mode is restored when releasing the throttle.

Following the enrichment mode, carburetors are operating normally, i.e. without additional pressure within bowls.

**NOTE:** Calibration is exactly the same on engines with a DPM Module and those without.

## Section 05 DIGITAL PERFORMANCE MANAGEMENT (DPM) SYSTEM

### Compensation Mode

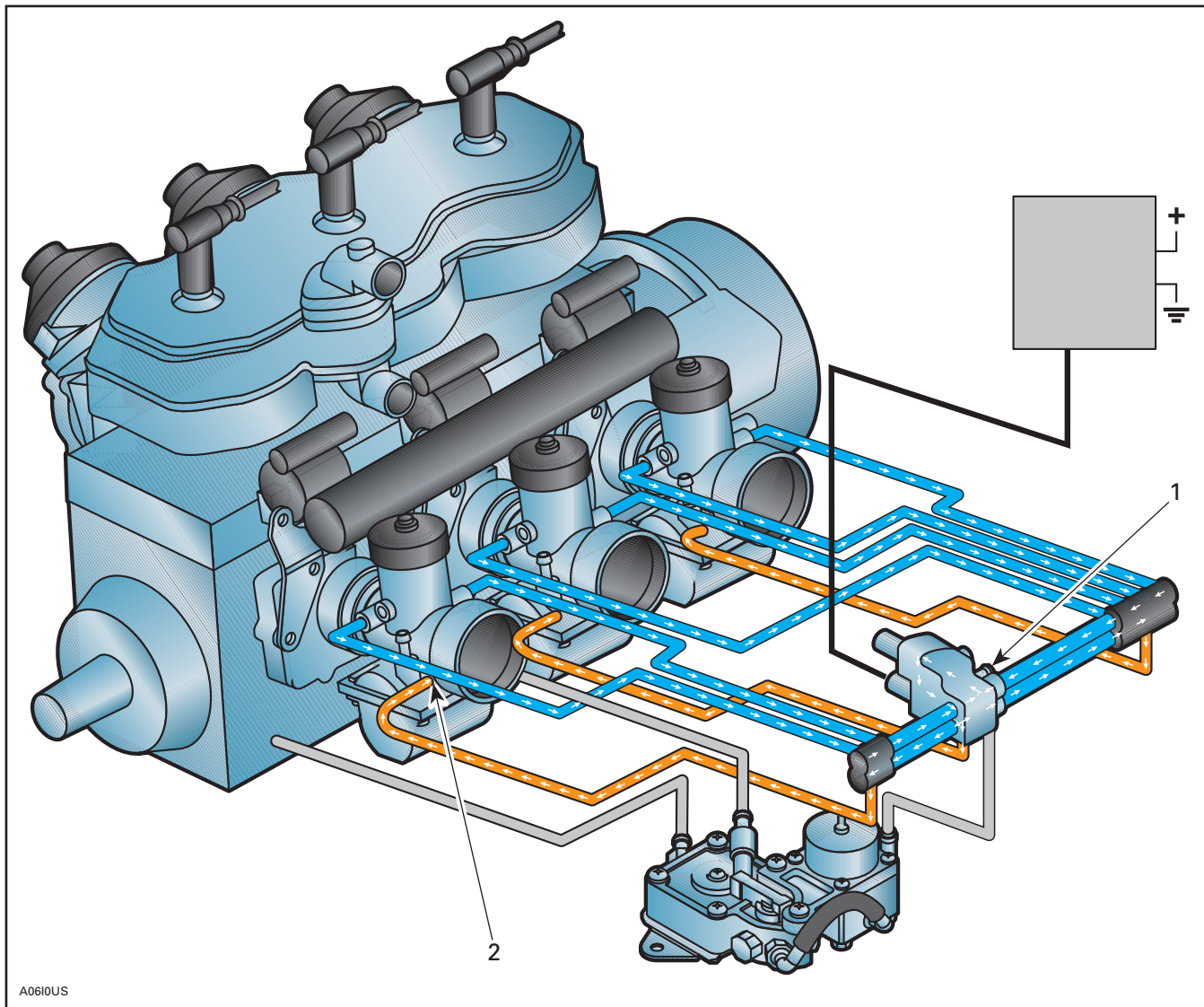

1. Air jet
2. Needle jet air inlet

Three conditions must be met for the compensation mode to operate:

1. The engine must operate at over 3000 RPM. Signal received by the GRAY/GREEN wire.
2. The air temperature must exceed  $-20^{\circ}\text{C}$  ( $-4^{\circ}\text{F}$ ).

3. The atmospheric pressure must be lower than 1000 mbar.

The system brings all 3 carburetor bowls under vacuum in order to make the air/fuel mixture leaner. The required vacuum is produced within the needle jet air inlet.

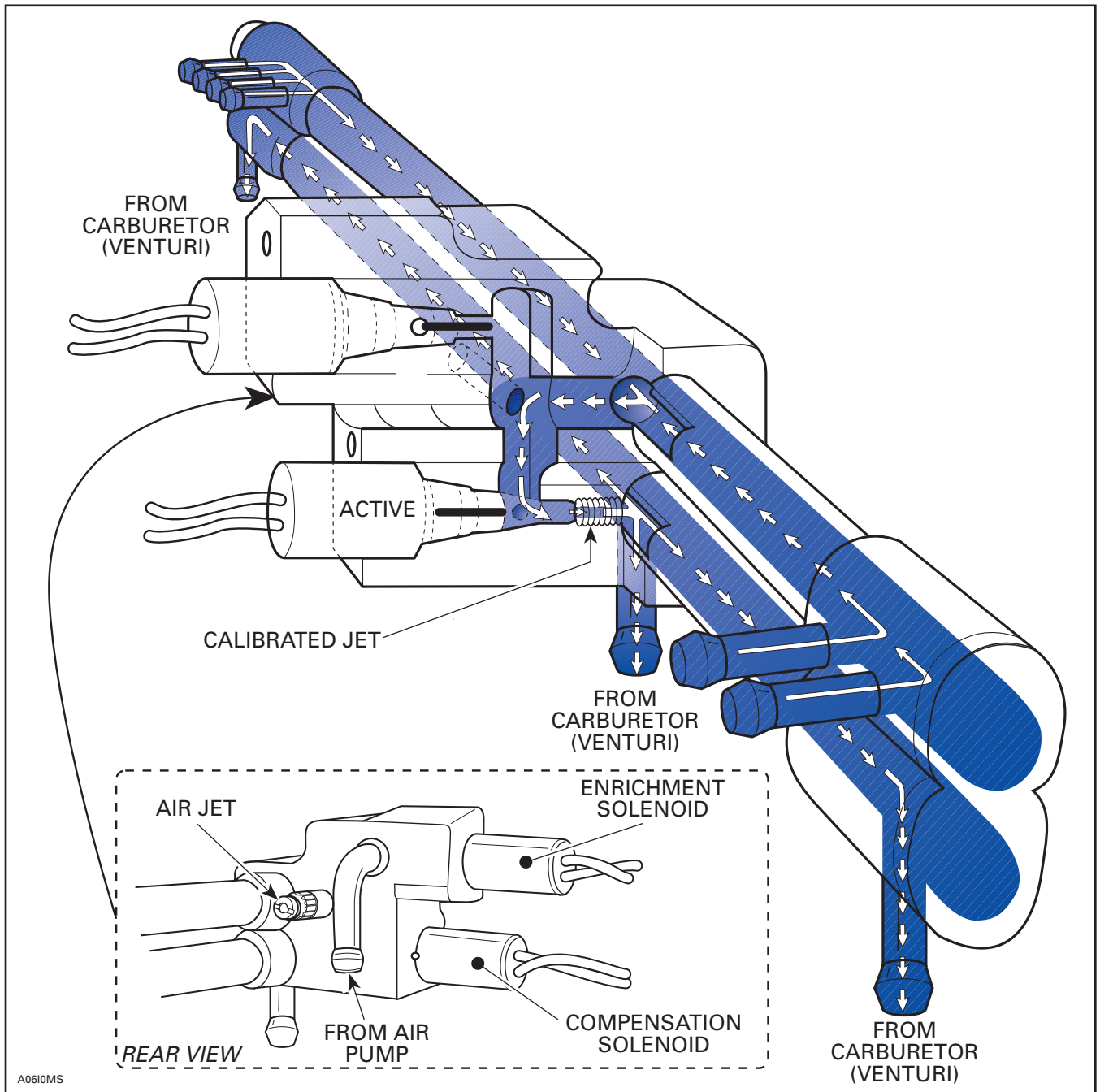

The compensation ratio will depend on the air temperature and the atmospheric pressure.

The higher the air temperature, the leaner the air/fuel mixture.

The lower the atmospheric pressure, the leaner the air/fuel mixture.

**NOTE:** The atmospheric pressure decreases as the altitude increases.

A0610MS



**AIR PUMP OPERATION**

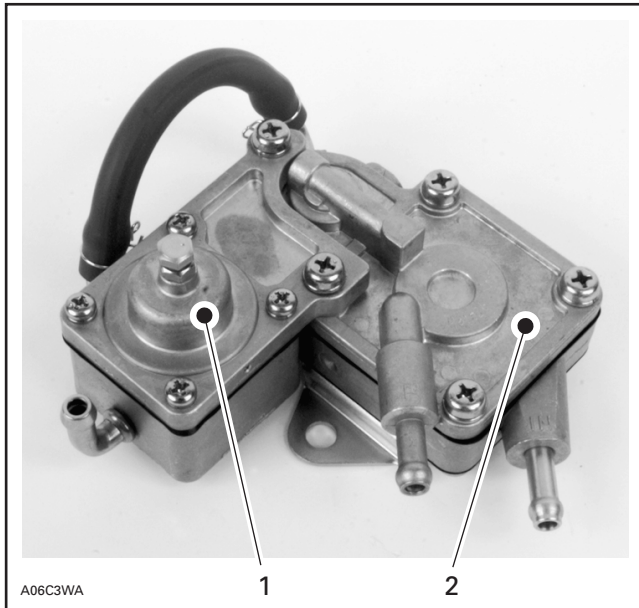

- 1. Regulator
- 2. Pump

This pump supplies the distribution gallery through a unique pipe.

The pump diaphragm is activated by the alternating pressure/vacuum within the engine crankcase. Two pipes connect the crankcase (cylinders nos. 2 and 3) to the pump.

A regulator within the pump stabilizes the pump pressure.

Since the pump pressure is insufficient upon starting, the regulator is fed directly by the crankcase pressure.

**DPM MANIFOLD OPERATION**

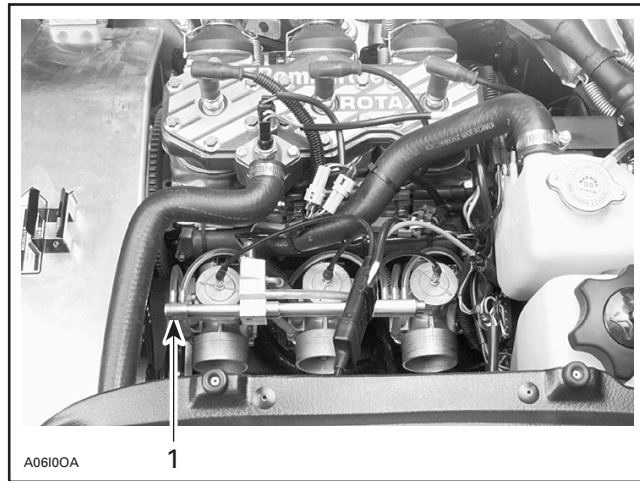

- 1. Manifold

The DPM manifold consists of 2 tubes. Depending on the mode, the upper tube (distribution gallery) distributes pump pressure or vacuum to each bowl through 2 pipes. The passage is then opened by the enrichment or the compensation solenoid, depending on the mode.

The lower tube (vacuum collector) receives the vacuum created by each carburetor within the needle jet air inlet.

An air jet also allows the atmospheric pressure to enter.

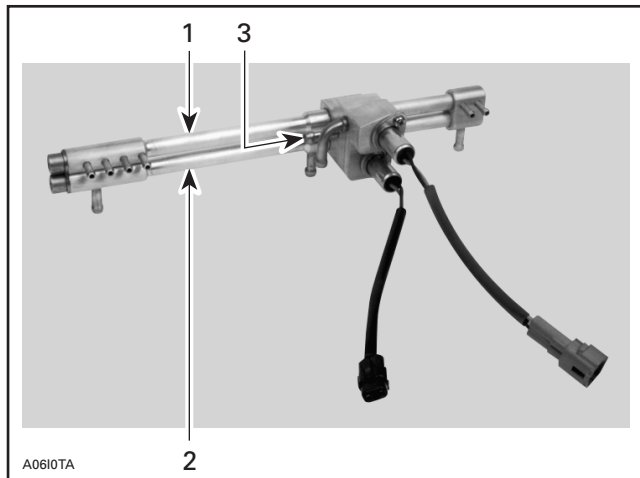

**MANIFOLD ASS'Y**

- 1. Upper tube: distribution gallery
- 2. Lower tube: vacuum collector
- 3. Air jet

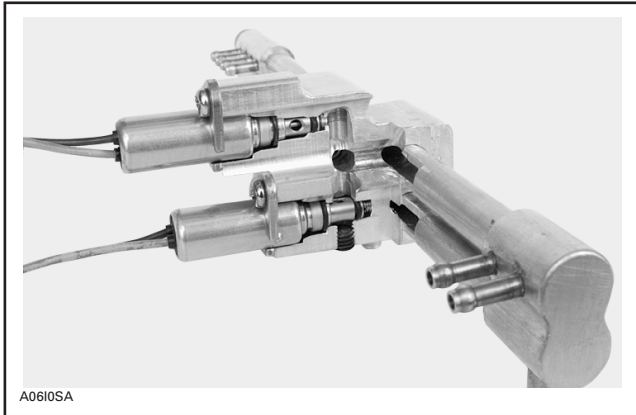

### Enrichment Solenoid

#### Solenoid Operating Principle

A solenoid is a winding coiled in order to produce a magnetic field. A metal rod crosses the coil and cuts the magnetic field. Each time the coil is activated, the magnetic field attracts the rod. If the supply current is interrupted, a spring pushes the rod.

#### Solenoid Function within the DPM System

The DPM module turns the solenoid on and off 10 times per second, which means that it operates at 10 cycles/second or 10 Hertz (Hz). The solenoid therefore opens and closes 10 times per second, thus allowing the pump pressure to reach the distribution gallery (upper tube).

For the pressure to vary within the bowls, the solenoid is activated in part by the DPM during each cycle. This is what is called the duty cycle. In other words, the solenoid will not open throughout the whole cycle. The duty cycle depends on the engine temperature.

The colder the engine, the longer the duty cycle. Therefore, the solenoid will stay open longer, thus giving way to pressure.

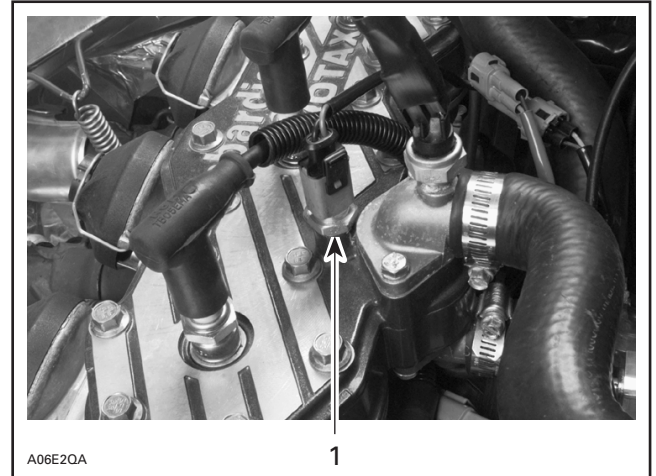

1. Engine temperature sensor

### Compensation Solenoid

**NOTE:** Read *Operating Principle of a Solenoid* at the beginning of the chapter concerning the enrichment solenoid.

The DPM module turns the solenoid on and off 10 times per second, which means that it operates at 10 cycles/second or 10 Hertz (Hz). The solenoid therefore opens and closes 10 times per second, thus allowing the pump pressure to reach the distribution gallery (upper tube).

For the vacuum to vary within the bowls, the solenoid is activated in part by the DPM module during each cycle. This is what is called the duty cycle. In other words, the solenoid will not open throughout the whole cycle. The duty cycle depends on the air temperature and the atmospheric pressure.

The warmer the air, the longer the duty cycle. Therefore, the solenoid will stay open longer, thus giving way to vacuum. The same applies when the altitude increases.

## Section 05 DIGITAL PERFORMANCE MANAGEMENT (DPM) SYSTEM

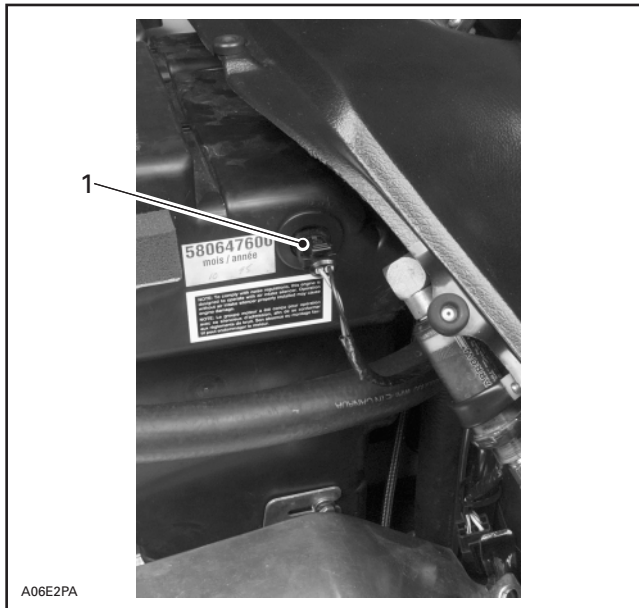

1. Air temperature sensor

### Manifold Air Jet

This jet allows the atmospheric pressure to reach carburetor bowls when the DPM is on standby. See manifold ass'y illustration.

## TESTING PROCEDURE

### Pump

#### Pressure test

The pump must create a minimum pressure of  $400 \pm 50$  mm of water. Connect a U-tube to pump outlet.

Start engine and note water height.

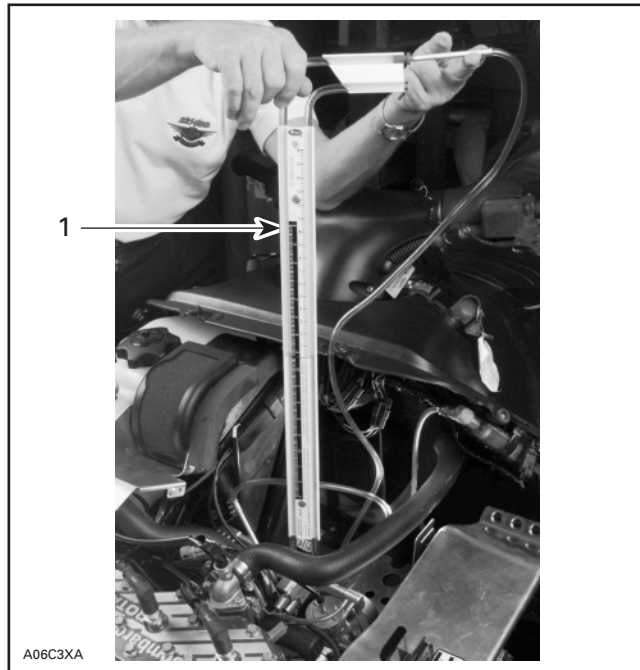

1. U-tube

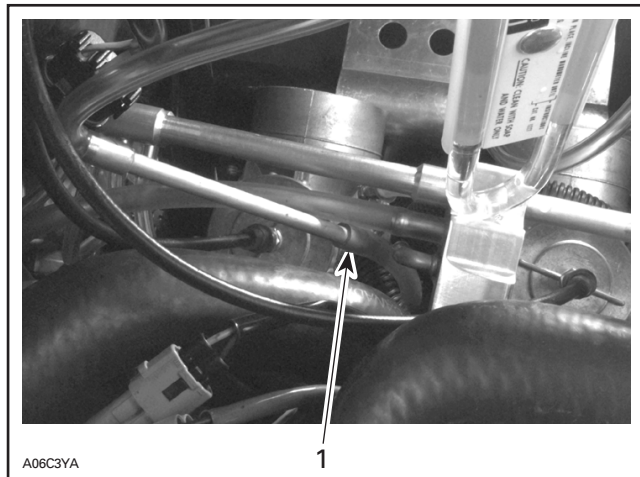

1. Pump outlet

### DPM Module

Solenoids are supplied by the DPM module. If this module does not work, there will be no current on the RE/WH and BK connectors (3-10 housing); and on the RE/GR and BK connectors (3-11 housing).

Unplug upper solenoid wire (enrichment). Connect a good solenoid to module output connector. Use adaptor (P/N 529 0338 00) as required.

### ▼ CAUTION

**Do not disconnect both DPM connectors. The compensation solenoid must remain plugged.**

Disconnect engine temperature sensor connector. The DPM module now operates as though the engine temperature was  $-20^{\circ}\text{C}$  ( $-4^{\circ}\text{F}$ ) to allow maximum mixture enrichment.

Start the engine and observe the solenoid. A vibrating solenoid indicates that the module is in good working order. If not, replace the module and repeat test.

### Solenoid

#### Static Test

Disassemble the solenoid and connect it to a 12 V battery. The solenoid must open and stay open. Repeat test several times.

At reassembly, ensure that solenoid seals are in place.

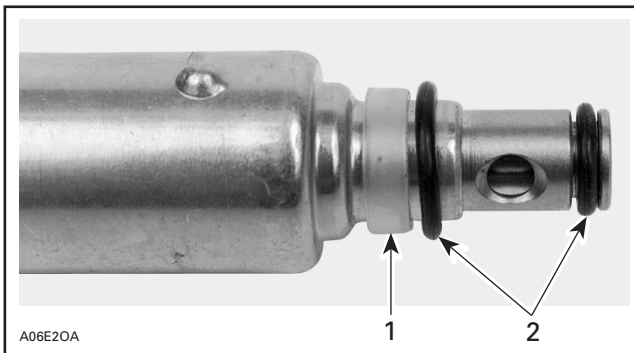

1. Plastic seal
2. O-rings

#### Dynamic test

When checking the enrichment solenoid, disconnect engine temperature sensor connector. The DPM module now operates as though the engine temperature was  $-20^{\circ}\text{C}$  ( $-4^{\circ}\text{F}$ ) to allow maximum mixture enrichment.

Remove the solenoid, hold it in hand and start the engine.

For the enrichment solenoid, check if it vibrates as soon as the engine is started.

For the compensation solenoid, the air temperature sensor must be at room temperature. Operate the engine at 3500 RPM. The solenoid must vibrate.

#### Temperature Sensor (air and engine)

At room temperature  $20^{\circ}\text{C}$  ( $68^{\circ}\text{F}$ ), the sensor resistance must be  $2500\ \Omega \pm 300$ .



# AIR SUSPENSION SYSTEM

## COMPONENT LOCATION

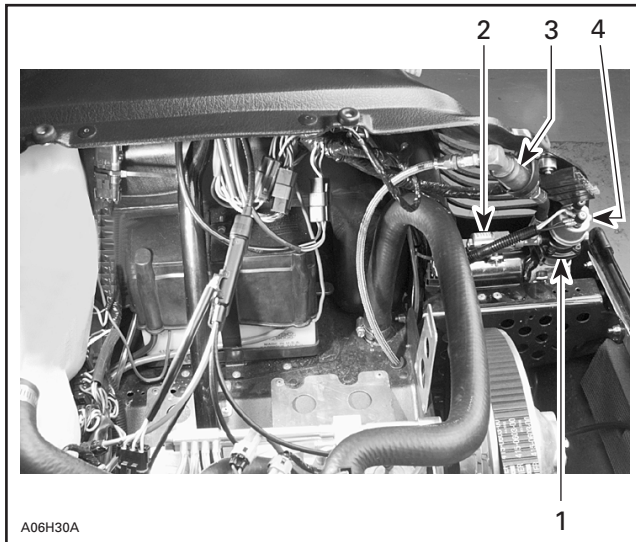

1. Compressor
2. Release valve
3. Desiccator
4. Pressure sensor

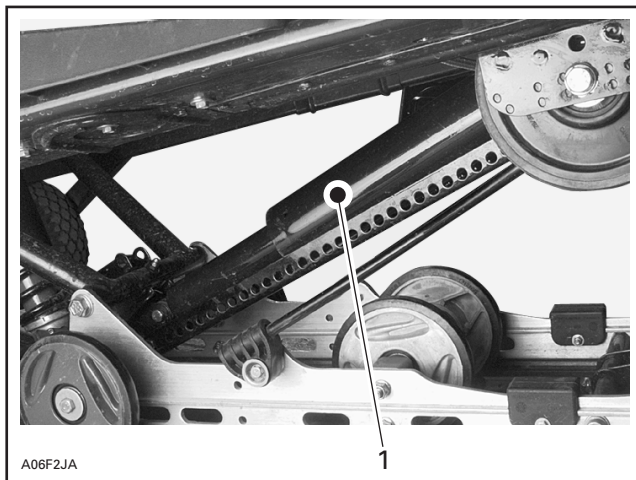

1. Pneumatic shock absorber

## THEORY AND OPERATION

A compressor creates a pressure within the rear shock absorber.

This shock absorber has been designed from a conventional shock absorber to which an airtight chamber has been added. A rubber boot connects the shock absorber body to the shock absorber piston rod.

The pressure in the air chamber increases when the compressor is activated, and it decreases when the release valve is activated. The compressor and the release valve are controlled by a three-way switch.

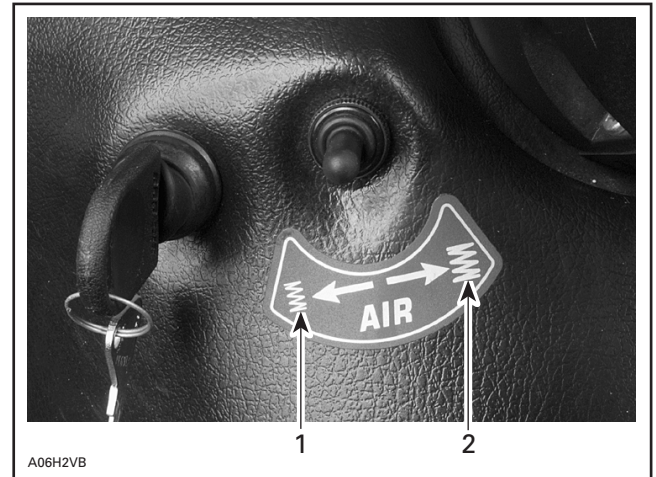

1. Activates the release valve
2. Activates the compressor

This shock absorber prevents the suspension from bouncing just like a conventional shock absorber. The air pressure within acts as a spring by increasing the preload.

## TESTING PROCEDURE

### Air Suspension System Tightness

Activate the compressor until the dashboard pressure gauge indicates more than half.

Remove the ignition key.

Connect an ohmmeter to pressure sensor connectors. No polarity need to be observed.

**NOTE:** The pressure sensor electrical resistance varies according to system pressure.

Note resistance and wait 3 minutes. The resistance should not decrease. If it does, there is a leak in the air system.

## Section 06 AIR SUSPENSION SYSTEM



Spray soapy water on fittings in order to locate leaks.

### Pressure Sensor

Release shock absorber pressure by activating the air suspension switch.

Remove the ignition key.

Plug an ohmmeter to pressure sensor connectors. No polarity need to be observed.

**NOTE:** The pressure sensor electrical resistance varies according to system pressure.

Compare the reading to the minimum value in the following table.

Disconnect ohmmeter. Activate compressor during 60 seconds.

Remove the ignition key.

Connect an ohmmeter to pressure sensor connectors. No polarity need to be observed.







Compare the reading to the maximum value in the following table.



PRESSURE	RESISTANCE ± 10 Ω
Minimum (residual pressure)	6
Maximum (60 sec. of compressor operation)	180





**NOTE:** The residual pressure prevents the shock absorber rubber boot from turning over. Otherwise, it would wear out by rubbing on itself.

ENGINE

	VEHICLE MODEL	GRAND TOURING SE		
	ENGINE TYPE	699		
	Number of Cylinders	3		
	Bore	mm (in)	69.75 (2.7461)	
	Stroke	mm (in)	61.0 (2.402)	
	Displacement	cm <sup>3</sup> (in <sup>3</sup> )	699.2 (42.7)	
	Compression Ratio (corrected)	6.8		
	Maximum Power Engine Speed ①	± 100 RPM	8500	
	Piston Ring Type	1 <sup>st</sup> /2 <sup>nd</sup>	ST/R	
	Ring End Gap	new	mm (in)	0.2 (.008)
		wear limit	mm (in)	1.0 (.039)
	Ring/Piston Groove Clearance	new	mm (in)	0.03 (.0012)
		wear limit	mm (in)	0.2 (.008)
	Piston/Cylinder Wall Clearance	new	mm (in)	0.10 (.0039)
		wear limit	mm (in)	0.15 (.0059)
	Connecting Rod Big End Axial Play	new	mm (in)	0.39 (.0154)
		wear limit	mm (in)	1.2 (.0472)
Maximum Crankshaft End-play ②	mm (in)	0.3 (.0118)		
Maximum Crankshaft Deflection	mm (in)	0.08 (.0031)		
Rotary Valve Timing ③ and P/N 420 924 XXX	Opening	Closing	N.A.	
	Magneto Generator Output	W	360	
	Ignition Type	CDI		
	Spark Plug Make and Type	NGK BR9ES		
	Spark Plug Gap	mm (in)	0.45 (.018)	
	Ignition Timing BTDC ④	mm (in)	2.18 (.086)	
	Trigger Coil ⑤	Ω	190 – 300	
	Generating Coil ⑤	Low Speed	Ω	N.A.
		High Speed	Ω	N.A.
	Lighting Coil ⑤	Ω	0.20 – 0.35	
	High Tension Coil ⑤	Primary	Ω	0.2 – 0.5
Secondary		kΩ	6 – 13	
	Carburetor Type	PTO/CTR/MAG	VM 38-372/373/372	
	Main Jet	PTO/CTR/MAG	350/350/350	
	Needle Jet	480 P-7		
	Pilot Jet	50		
	Needle Identification – Clip Position	6DEY2-4		
	Slide Cut-away	2.5		
	Float Adjustment	± 1 mm (± .040 in)	18.1 (.71)	
	Air Screw Adjustment	± 1/16 Turn	2-1/4	
	Idle Speed	± 200 RPM	1800	
	Gas Type/Pump Octane Number	Super Unleaded/91		
	Gas/Oil Ratio	Injection		
	Type	Liquid		
	Axial Fan Belt Adjustment	Deflection ⑥	mm (in)	N.A.
		Force	kg (lbf)	N.A.
	Thermostat Opening Temperature	°C (°F)	42 (108)	
Radiator Cap Opening Pressure	kPa (PSI)	90 (13)		
	ENGINE COLD N·m (lb·ft)	Drive Pulley Retaining Screw	⑦	
		Exhaust Manifold Nuts or Bolts	9 (6.6)	
		Magneto Ring Nut	125 (92)	
		Crankcase Nuts or Screws	M6	13 (9.5)
			M8	22 (16)
		Crankcase/Engine Support Nuts or Screws	13 (9.6)	
		Cylinder Head Nuts	29 (21)	
		Crankcase/Cylinder Nuts or Screws	29 (21)	
Axial Fan Shaft Nut	N.A.			

## Section 07 TECHNICAL DATA

### VEHICLE

		VEHICLE MODEL	GRAND TOURING SE	
		<b>ENGINE TYPE</b>	<b>699</b>	
		Chain Drive Ratio	25/44	
Chain	Pitch	in	3/8	
	Type/Links Qty/Plates Qty		Silent/74/13	
Drive Pulley	Type of Drive Pulley		TRAC	
	Ramp Identification		286 ⑥	
	Calibration Screw Position or Calibration Disc Quantity		4	
	Spring Color		Blue/Pink	
	Spring Length	± 1.5 mm (± 0.060 in)		93.5 (3.68)
	Clutch Engagement	± 200 RPM		3600
Driven Pulley Spring Preload		± 0.7 kg (±1.5 lb)	7.0 (15.4)	
Cam Angle		degree	47°	
Pulley Distance Z		(+ 0, -1) mm (+ 0, -1/32) in	16.5 (21/32)	
Offset	X	± 0.4 mm (± 1/64 in)	35.0 (1-3/8)	
	Y - X	MIN. - MAX.	mm (in)	1.0 - 2.0 (0.039 - 0.079)
Drive Belt Part Number (P/N)			415 0603 00	
Drive Belt Width (new) ①		mm (in)	35.0 (1-3/8)	
Drive Belt Adjustment		Deflection	± 5 mm (± 13/64 in)	32 (1-1/4)
		Force ②	kg (lbf)	11.3 (25)
Track	Width	cm (in)	38.1 (15.0)	
	Length	cm (in)	345.5 (136)	
	Adjustment	Deflection	mm (in)	35 - 40 (1-3/8 - 1-3/4)
		Force ③	kg (lbf)	7.3 (16)
Suspension Type		Track	SC-10 Touring	
		Ski	DSA	
	Length	cm (in)	302.0 (118.9)	
	Width	cm (in)	120.7 (47.5)	
	Height	cm (in)	128.3 (50.5)	
	Ski Stance	cm (in)	106.7 (42)	
	Mass (dry)	kg (lb)	285 (628)	
	Ground Contact Area	cm <sup>2</sup> (in <sup>2</sup> )	7479 (1159)	
	Ground Contact Pressure	kPa (PSI)	3.74 (.542)	
	Frame Material		Aluminum	
	Bottom Pan Material		Impact Copolymer	
	Hood Material		RRIM Polyurethane	
	Battery	V (A•h)	12 (22)	
	Headlight	W	H4 60/55	
	Taillight and Stoplight	W	8/27	
	Tachometer and Speedometer Bulb	W	2 x 3	
	Fuel and Temperature Gauge Bulb	W	3/3	
	Fuse	Starter Solenoid	A	30
Tachometer		A	N.A.	
	Fuel Tank	L (U.S. gal)	42 (11.1)	
	Chaincase/Gearbox	mL (U.S. oz)	250 (8.5)	
	Cooling System ④	L (U.S. oz)	5.1 (172.5)	
	Injection Oil Reservoir	L (U.S. oz)	4.1 (139)	

## ENGINE LEGEND

CDI: Capacitor Discharge Ignition

BTDC: Before Top Dead Center

CTR: Center

K: Kilo (× 1000)

MAG: Magneto Side

PTO: Power Take Off Side

R: Rectangular

N.A.: Not Applicable

ST: Semi-trapez

- ① The maximum power engine speed is applicable on the vehicle. It may be different under certain circumstances and **BOMBARDIER INC.** reserves the right to modify it without obligation.
- ② Crankshaft end-play is not adjustable on these models. Specification is given for verification purposes only.
- ③ Rotary valve to crankcase clearance: 0.27 – 0.48 mm (.011 – .019 in).
- ④ At 6000 RPM (engine cold) with headlamp turned on.
- ⑤ All resistance measurements must be performed with parts at room temperature (approx. 20°C (68°F)). Temperature greatly affects resistance measurements.
- ⑥ Force applied midway between pulleys to obtain specified tension deflection.
- ⑦ Drive pulley retaining screw: torque to 90 to 100 N•m (66 to 74 lbf•ft), install drive belt, accelerate the vehicle at low speed (maximum 30 km / h (20 MPH)) and apply the brake; repeat 5 times. Recheck the torque of 90 to 100 N•m (66 to 74 lbf•ft).

## VEHICLE LEGEND

DSA: Direct Shock Action

RRIM: Reinforced Reaction Injection Molding

TRA: Total Range Adjustable

N.A.: Not Applicable

- ① Minimum allowable width may not be less than 3.0 mm (1/8 in) of new drive belt.
- ② Force applied midway between pulleys to obtain specified tension deflection.
- ③ Force or downward pull applied to track to obtain specified tension deflection.
- ④ Coolant mixture: 60% antifreeze/40% water.
- ⑤ Lever with roller pin P/N 417 0043 03 (hollow).
- ⑥ Lever with roller pin P/N 417 0043 04 (solid).



# WIRING DIAGRAM

## COMPONENT LOCATION

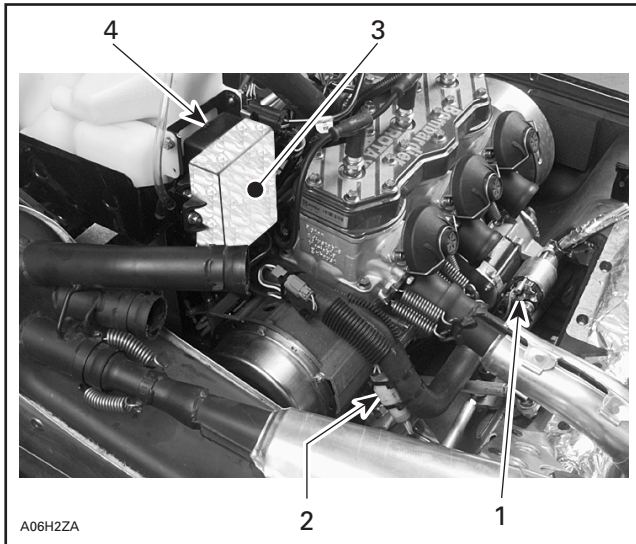

- 1. Starter wires
- 2. Magneto wires
- 3. MPEM: (ignition system and DESS)
- 4. DPM module

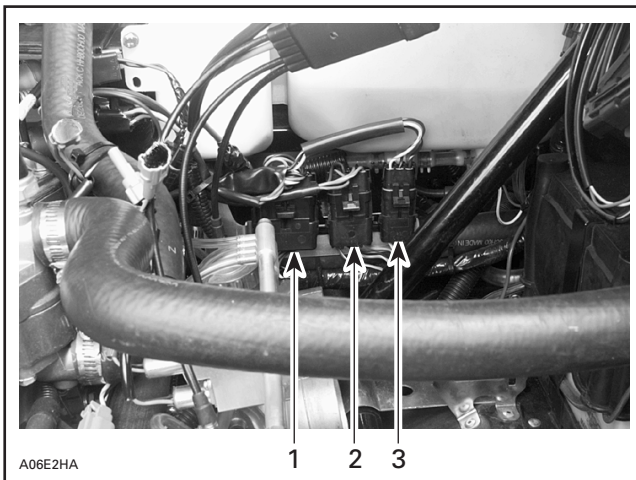

- 1. MPEM: 3-06 housing
- 2. MPEM: 3-02 housing
- 3. DPM: 3-07 housing

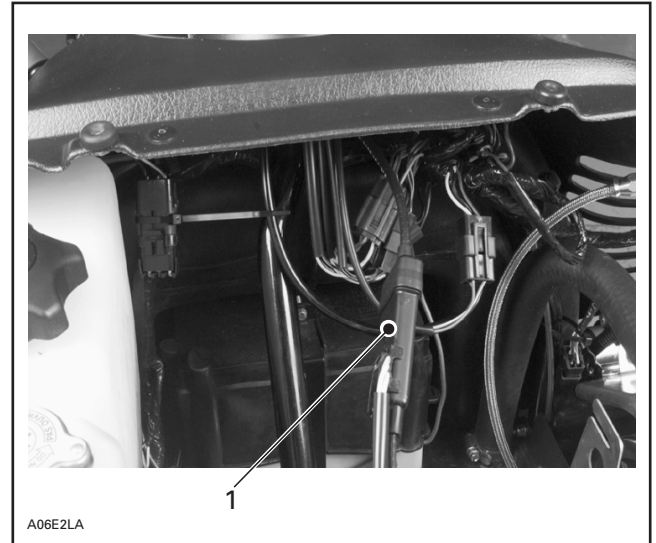

- 1. DPM enrichment switch



HIGH-TENSION COIL

---

**Section 08 WIRING DIAGRAM**

---



GAUGES

### WIRING DIAGRAM LEGEND

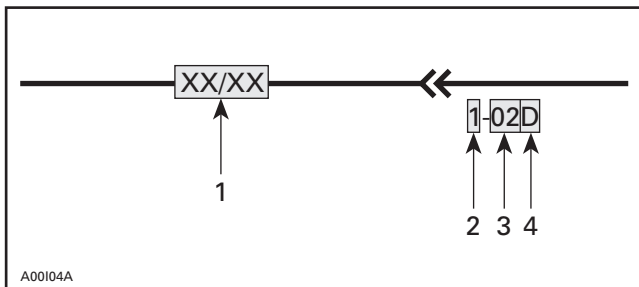

1. Wire colors
2. Housing area
3. Housing number per area
4. Wire connector location in housing

### WIRE COLORS AND CIRCUIT

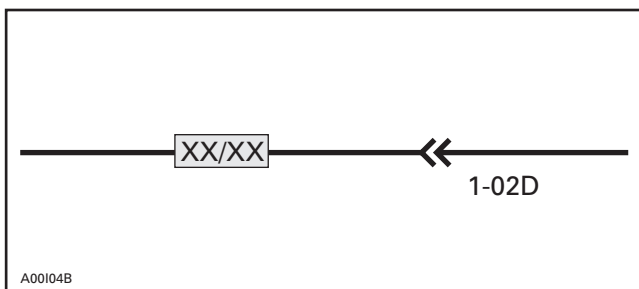

CODE	CIRCUIT
WH	Rear brake light
WH/BL	Ignition: between CDI and coils
WH/GY	Safety lanyard cap
WH/YL	Trigger coil wire no. 1
WH/BK	DESS pilot lamp (-)
WH/GN	Magneto output/360-W tachometer signal
TA/BK	Back-up alarm
TA	Back-up alarm switch
BR	Heated lever
BL	Fuel level sender; DPM enrichment switch
BL/YL	Trigger coil wire no. 2
GY	High beam
GY/GN	Engine speed signal from ADC to DPM
GY/VI	Low beam
YL	Alternating current supply AC +
YL	Direct current supply; rear light and heated grip
YL/BR	Compressor
YL/GN	Release valve
BK	Engine ground, frame, DC battery-, enrichment switch ground, DPM
BK/WH	Engine stopping: closed ignition ON
BK/YL	Engine stopping; opened ignition ON
BK/GN	Digital signals ground: ROM key
OR	Heated grips
RD	DC + battery, DPM enrichment switch supply
RD/WH	DC +: 30A fuse, DPM compensation solenoid
RD/BL	DC + regulator output
RD/GY	DPM supply
RD/YL	Loads supply
RD/OR	Compressor supply
RD/GN	Starter solenoid, DPM enrichment solenoid
RD/VI	DPM fuses, compressor and discharge plunger supply
GN	Coolant temperature (gauge)
VI	Coolant temperature, DPM coolant temperature (binary)
VI/WH	Air intake temperature



## Section 08 WIRING DIAGRAM

### CONNECTOR HOUSING AREA

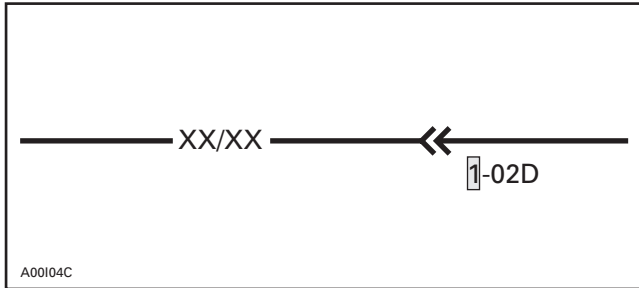



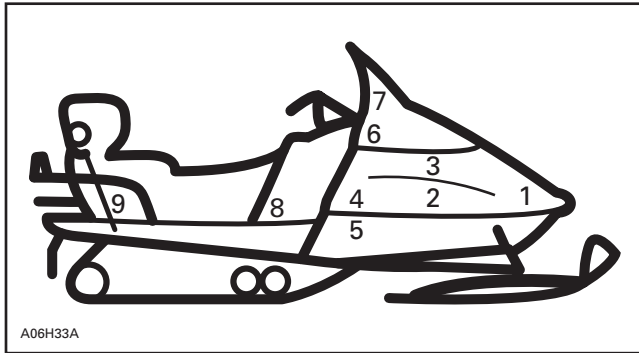
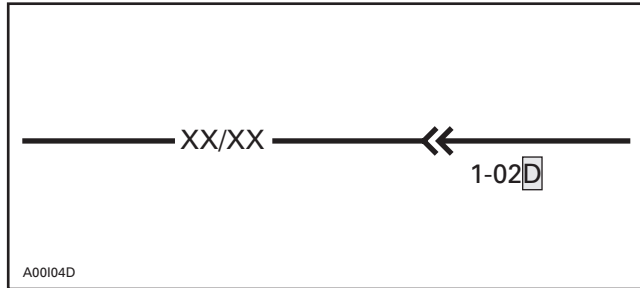



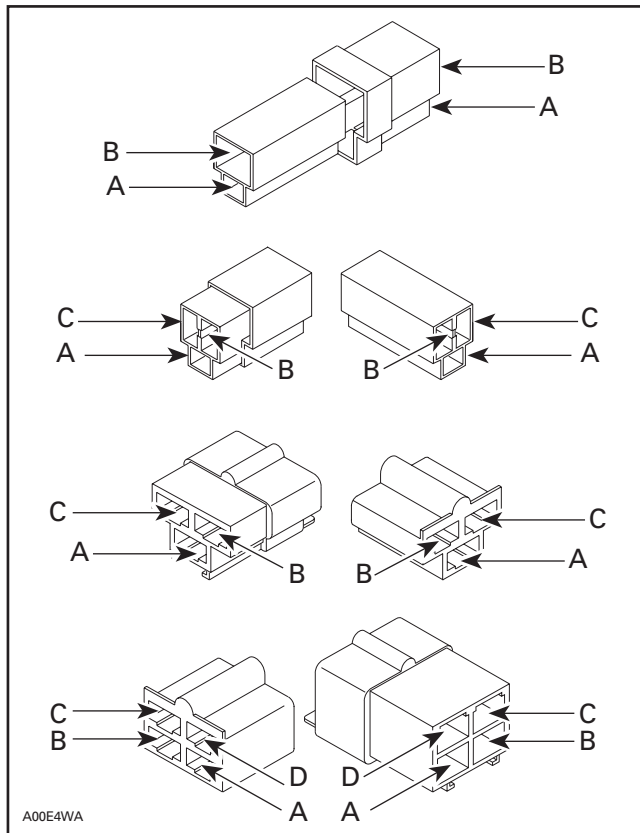

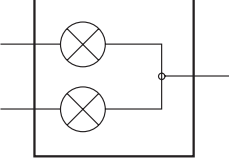
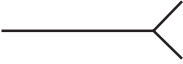
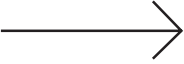
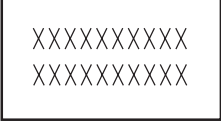
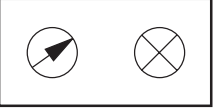
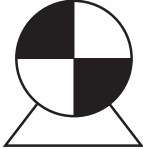
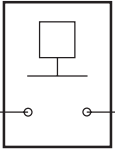
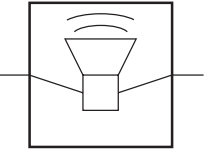
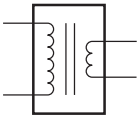
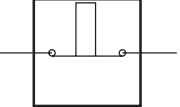
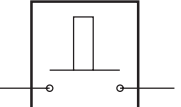

### CONNECTOR LOCATION IN HOUSING

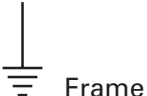

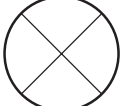
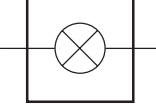
AREA	LOCATION
1	Frame and hood junction
2	Magneto
3	Carburetors
4	Rear of intake silencer
5	Near driven pulley
6	Under handlebar
7	Under hood
8	Near fuel tank
9	Rear of seat

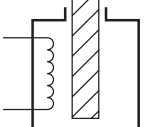

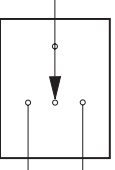
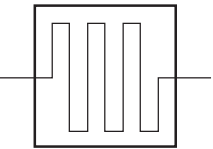
**SYMBOLS DESCRIPTION**

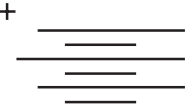
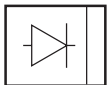
<p>Beam and tail light</p> 	<p>Female terminal</p> 	<p>Male terminal</p> 	<p>Electronic module</p> 
<p>Meter</p> 	<p>Electric motor</p> 	<p>Low level sensor</p> 	<p>Buzzer</p> 
<p>Ignition coil</p> 	<p>Normally close switch</p> 	<p>Normally open switch</p> 	<p>Male terminal on instrument</p> 
<p>Engine ground</p> 	<p>Frame ground</p> 	<p>Spark plug</p> 	<p>Meter movement</p> 
<p>Bulb</p> 	<p>Pilot light</p> 	<p>Analog sensor</p> 	<p>Solenoid valve</p> 
<p>Magneto</p> 	<p>3 position switch</p> 	<p>Heating element</p> 	<p>Fuse</p> 
<p>Trigger coil</p> 	<p>Battery</p> 	<p>Diode</p> 	

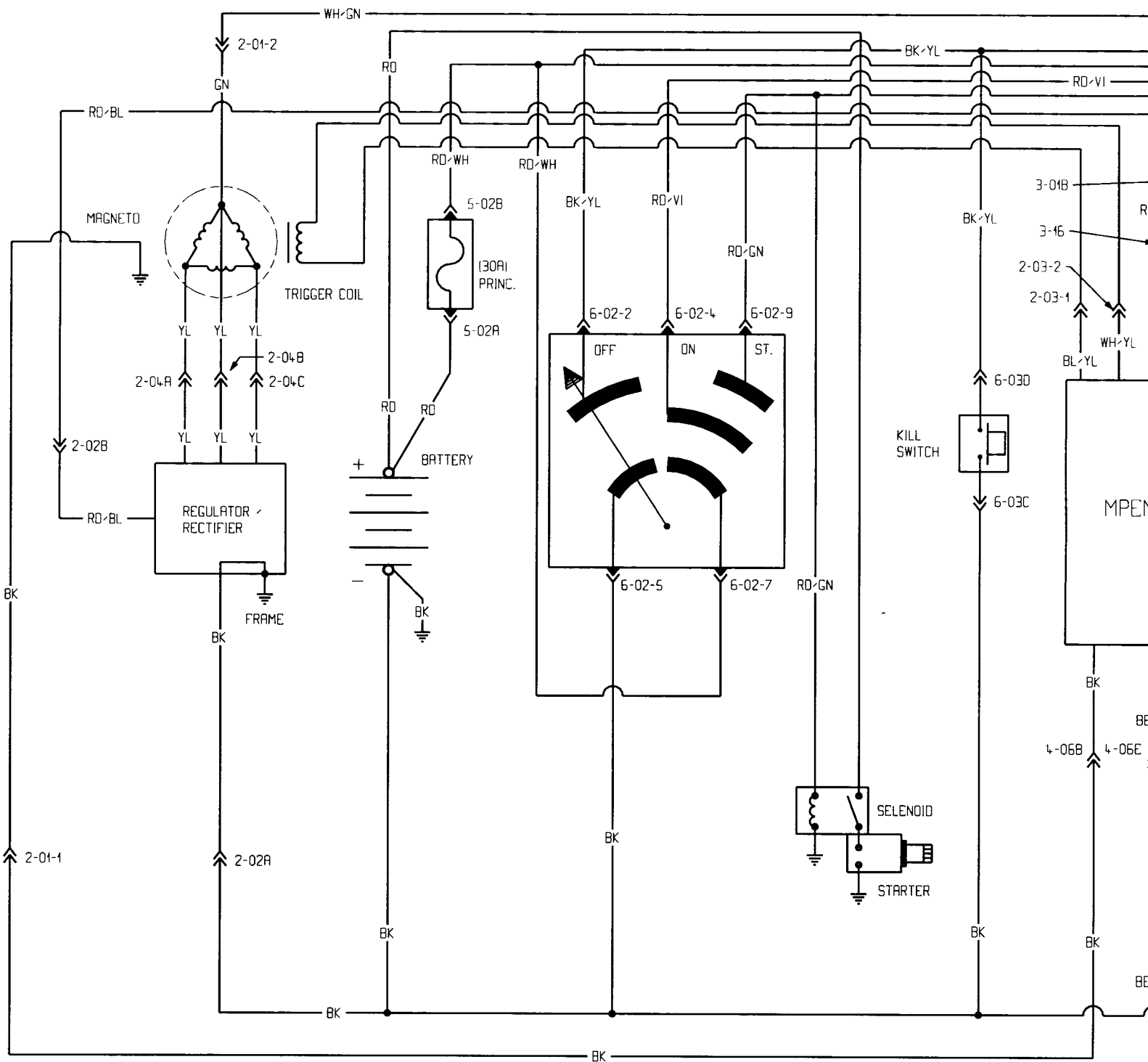

POWER SUPPLY SYSTEM

STARTER AND IGNITION SWITCHES

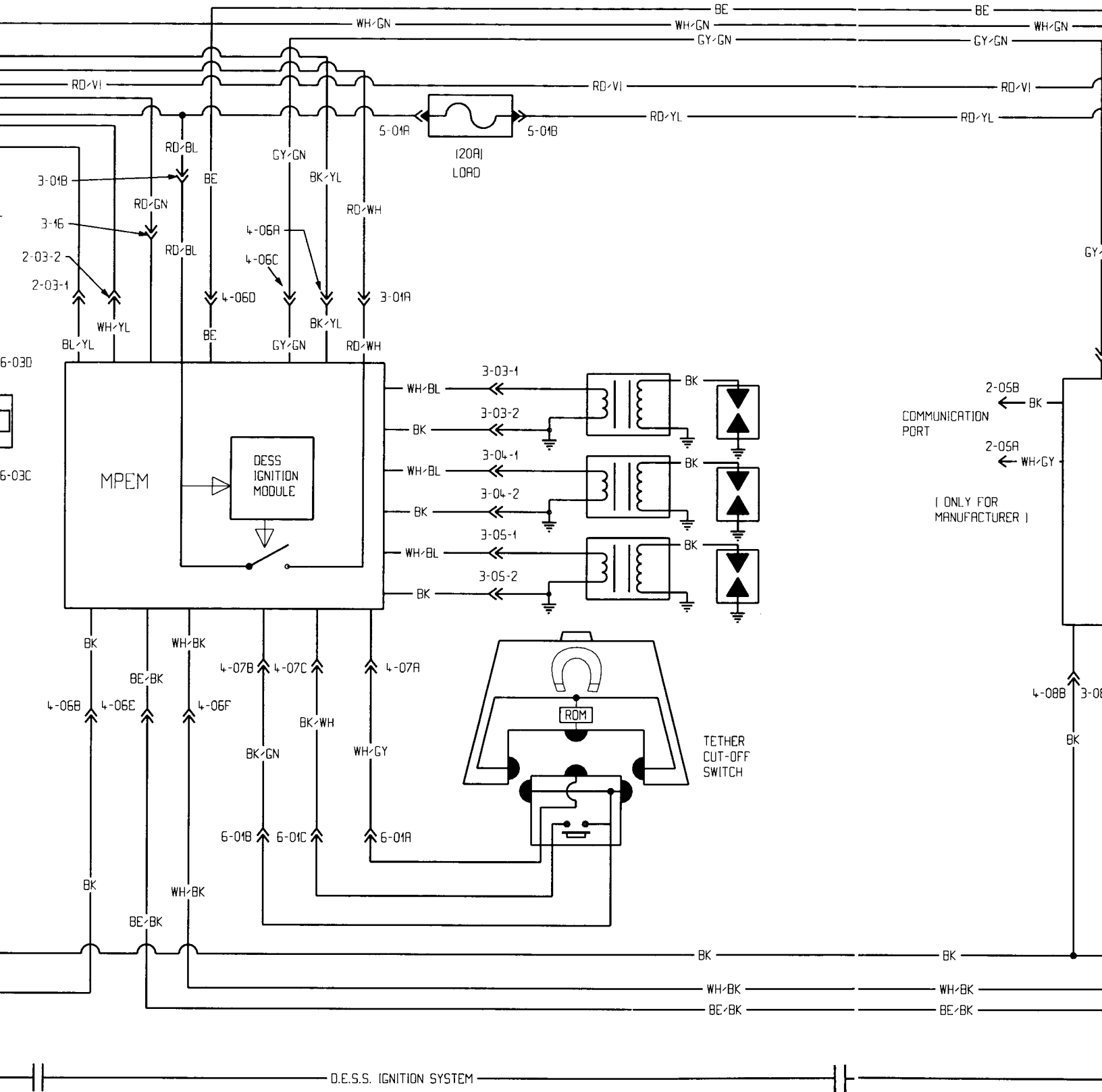

D.E.S.S. IGNITION SYSTEM

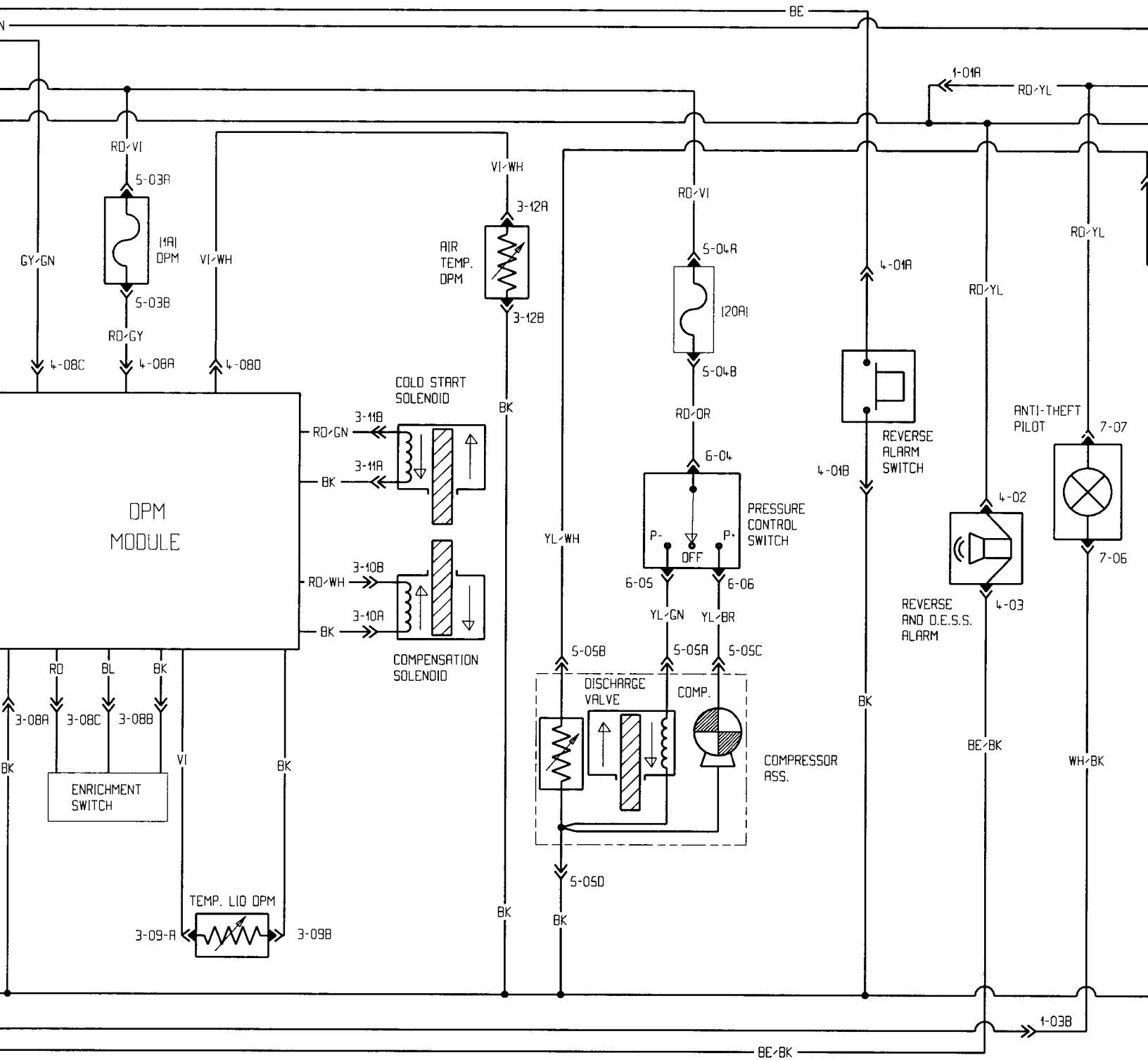

DPM SYSTEM

AIR SUSPENSION  
CONTROL SYSTEM

ALARM SYSTEM

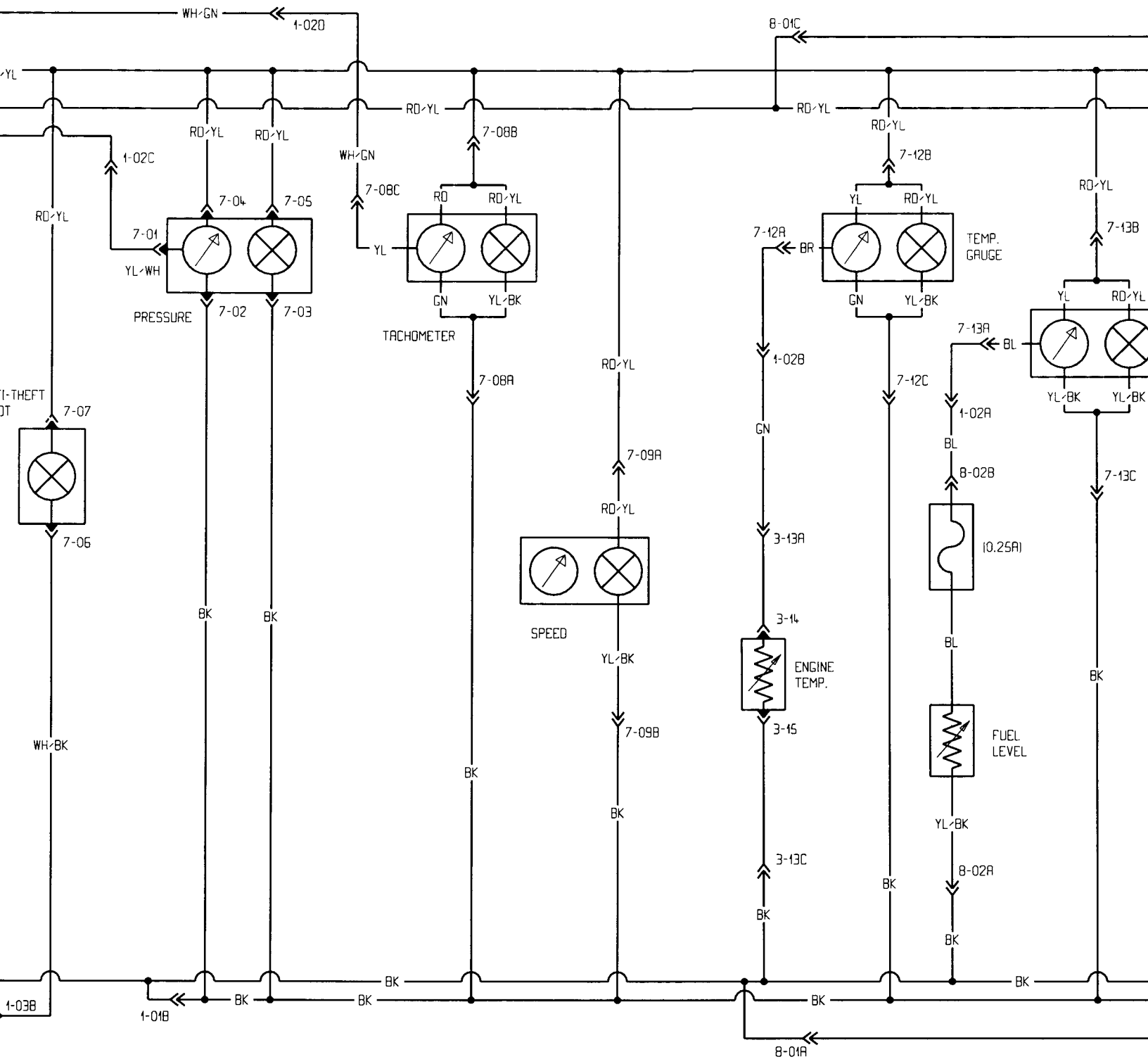

INSTRUMENTATION



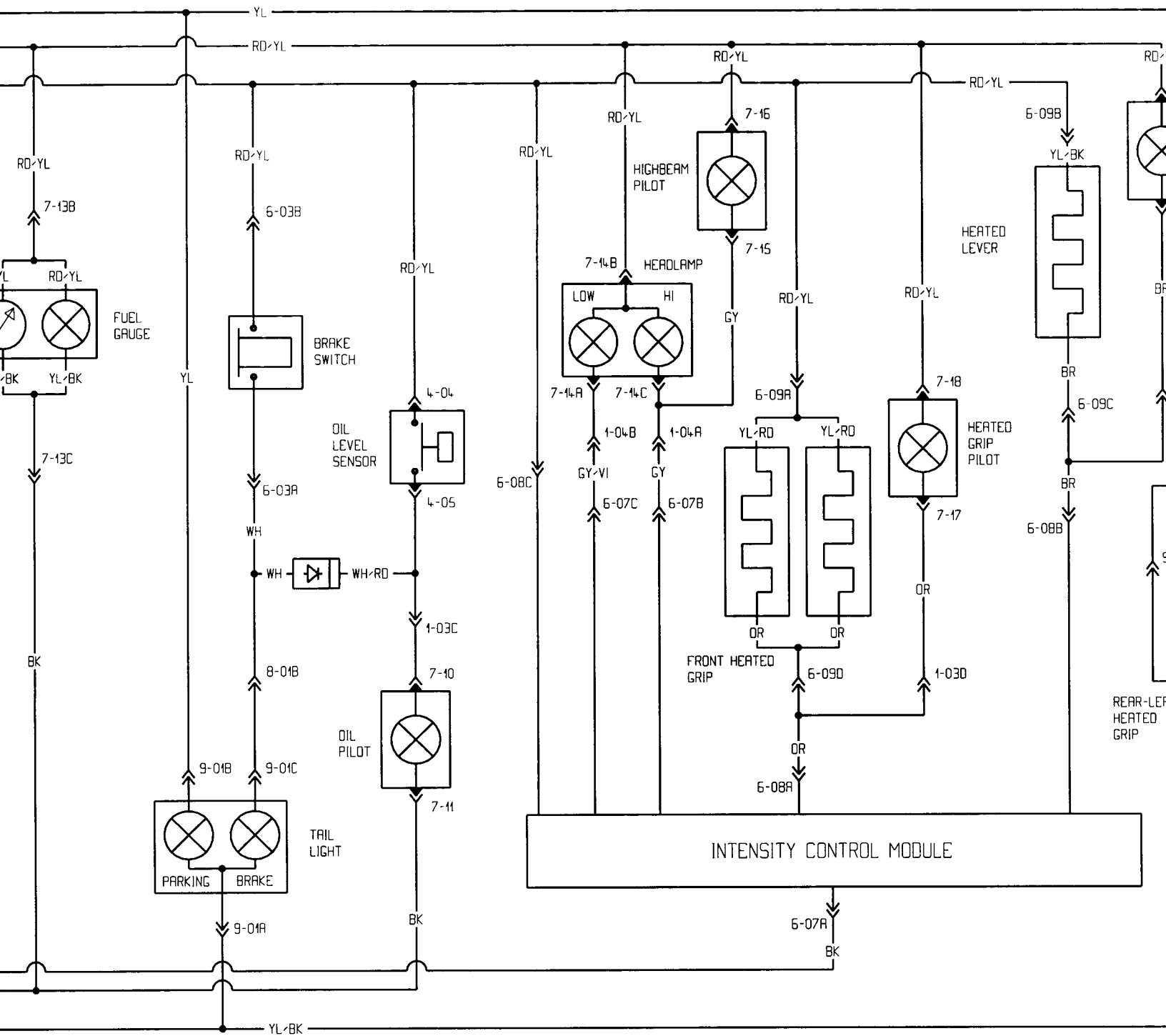

TAIL LAMP AND  
OIL PILOT LAMP

HEATING ELEMENTS AND  
HEAD LIGHT CONTROL

**WARNING:** ENSURE ALL TERMINALS ARE PROPERLY CRIMPED ON THE WIRES AND ALL CONNECTOR HOUSINGS ARE PROPERLY FASTENED.

BK - BL
WH - WH
RD - RE
BL - BL
YL - YE

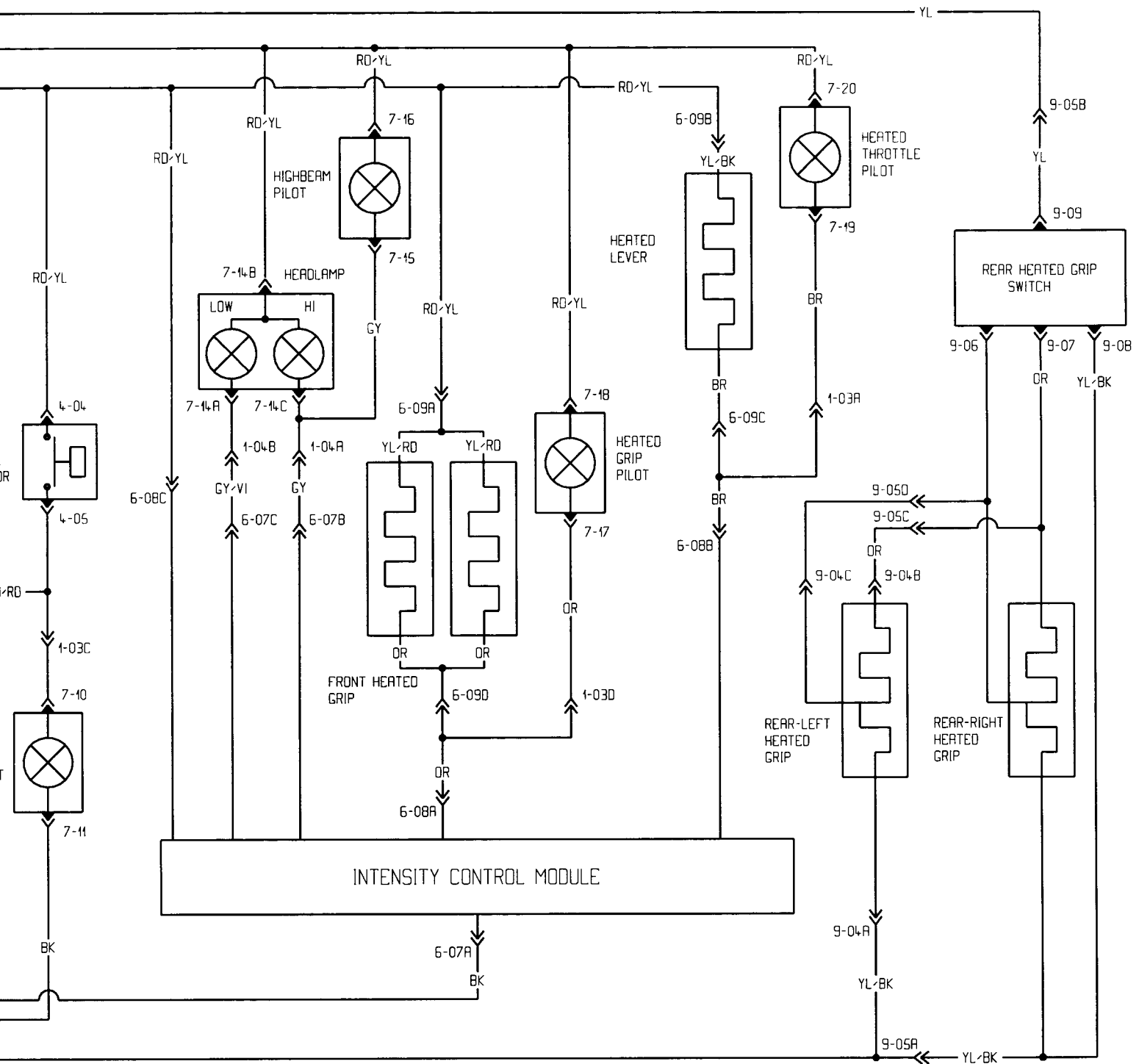

HEATING ELEMENTS AND HEAD LIGHT CONTROL

REAR HEAT GRIPS CONTROL

ENSURE ALL TERMINALS ARE PROPERLY CRIMPED ON THE WIRES AND ALL CONNECTOR HOUSINGS ARE PROPERLY FASTENED.

COLOR CODE		
BK - BLACK	GN - GREEN	BE - BEIGE
WH - WHITE	GY - GREY	
RD - RED	VI - VIOLET	
BL - BLUE	OR - ORANGE	
YL - YELLOW	BR - BROWN	